

### Description

The PESDUC2XD5VB protects sensitive semiconductor components from damage or upset due to electrostatic discharge (ESD) and other voltage induced transient events. They feature large cross-sectional area junctions for conducting high transient currents, offer desirable electrical characteristics for board level protection, such as fast response time, low operating voltage. It gives designer the flexibility to protect one unidirectional line in applications where arrays are not practical.



**DFN0603-2L(Bottom View)**

### Feature

- DFN0603-2L package
- Replacement for MLV(0201)
- Bidirectional configurations
- Response time is typically < 1 ns
- Low clamping voltage
- RoHS compliant
- Transient protection for data lines to IEC 61000-4-2(ESD) ±30KV(air), ±30KV(contact); IEC 61000-4-4 (EFT) 50A (5/50ns)

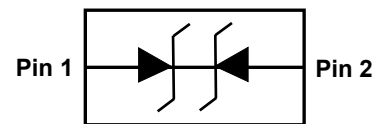

**Circuit Diagram**

### Applications

- Cellular phones
- Portable devices
- Digital cameras
- Power supplies



**Marking (Top View)**

### Mechanical Characteristics

- Mounting position: Any
- Qualified max reflow temperature:260°C
- Device meets MSL 1 requirements
- DFN0603-2L without plating

Electronics Parameter

Symbol	Parameter
$V_{RWM}$	Peak Reverse Working Voltage
$I_R$	Reverse Leakage Current @ $V_{RWM}$
$V_{BR}$	Breakdown Voltage @ $I_T$
$I_T$	Test Current
$I_{PP}$	Maximum Reverse Peak Pulse Current
$V_C$	Clamping Voltage @ $I_{PP}$
$P_{PP}$	Peak Pulse Power
$C_J$	Junction Capacitance
$I_F$	Forward Current
$V_F$	Forward Voltage @ $I_F$

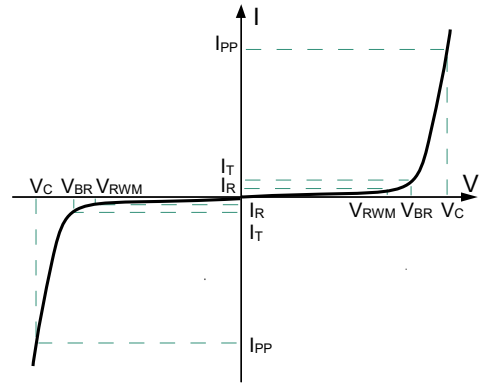

Electrical characteristics per line@25°C ( unless otherwise specified)

Parameter	Symbol	Conditions	Min.	Typ.	Max.	Units
Peak Reverse Working Voltage	$V_{RWM}$				5.0	V
Breakdown Voltage	$V_{BR}$	$I_t = 1mA$	5.6		10.5	V
Reverse Leakage Current	$I_R$	$V_{RWM} = 5V$ $T=25^\circ C$			1	$\mu A$
Clamping Voltage	$V_{CL}$	$I_{PP}=16A$ $t_p=100ns$		27	29	V
Clamping Voltage	$V_C$	$I_{PP} = 1A$ $t_p = 8/20\mu s$		11	13	V
Clamping Voltage	$V_C$	$I_{PP} = 4A$ $t_p = 8/20\mu s$		21	23	V
Junction Capacitance	$C_j$	$V_R=0V$ $f = 1MHz$		0.37	0.52	pF

Absolute maximum rating@25°C

Rating	Symbol	Value	Units
Peak pulse power( $t_p=8/20\mu s$ )	$P_{PP}$	80	W
Peak pulse current( $t_p=8/20\mu s$ )	$I_{PP}$	4	A
Operating Temperature	$T_J$	-55 to 150	$^\circ C$
Storage Temperature	$T_{STG}$	-55 to 150	$^\circ C$

Typical Characteristics

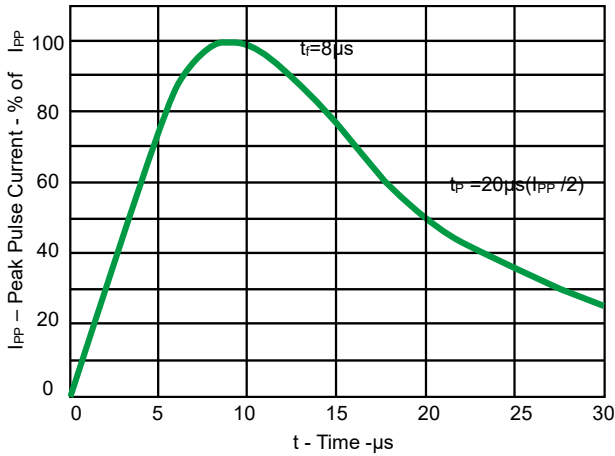

Fig 1. Pulse Waveform

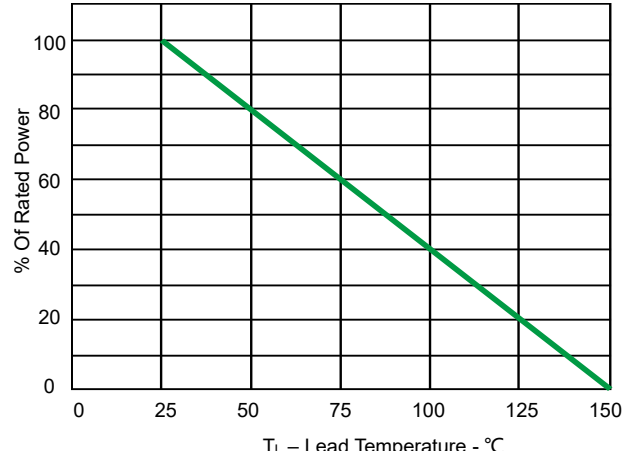

Fig 2. Power Derating Curve

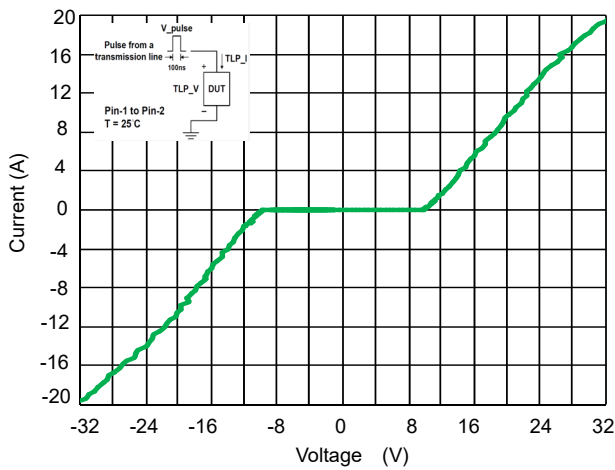

Fig 3. TLP Measurement

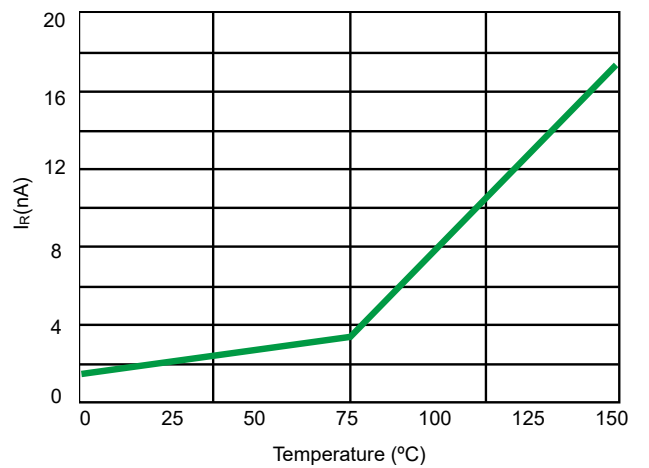

Fig 4. Typical Leakage Current vs. Temperature

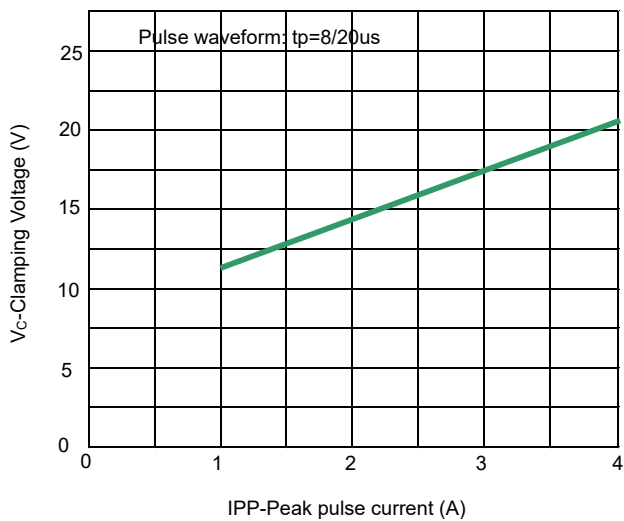

Fig 5. Clamping voltage vs. Peak pulse current

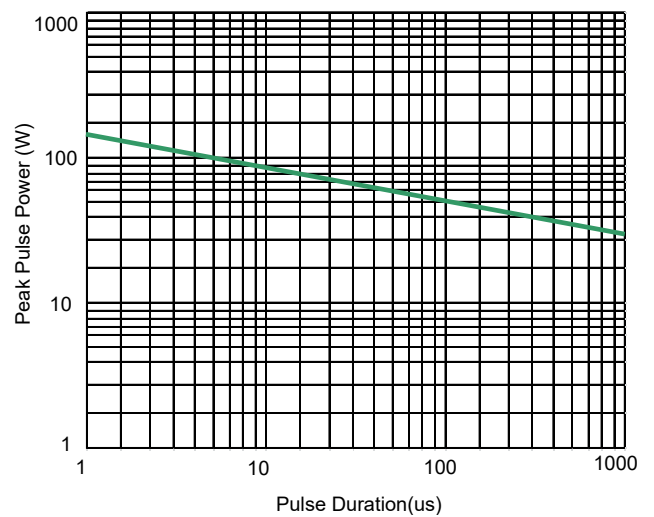

Fig 6. Non-Repetitive Peak Pulse Power vs. Pulse time

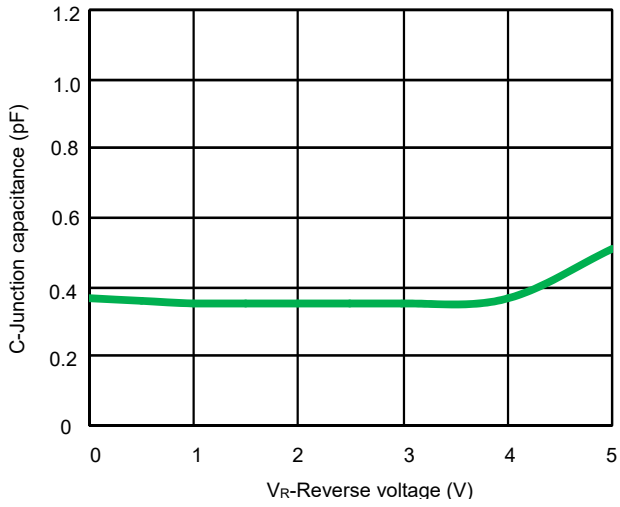

Fig 7. Capacitance vs. Reverse voltage

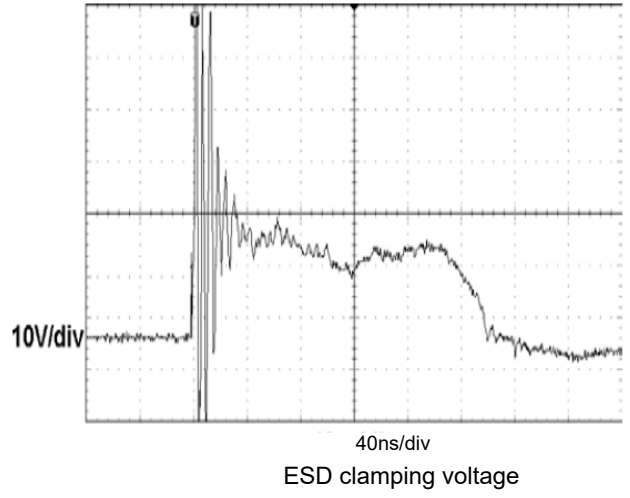

Fig 8. (IEC61000-4-2 +8KV contact)

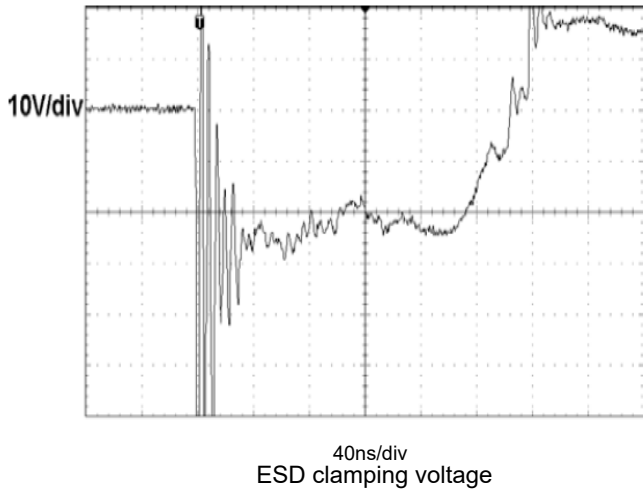
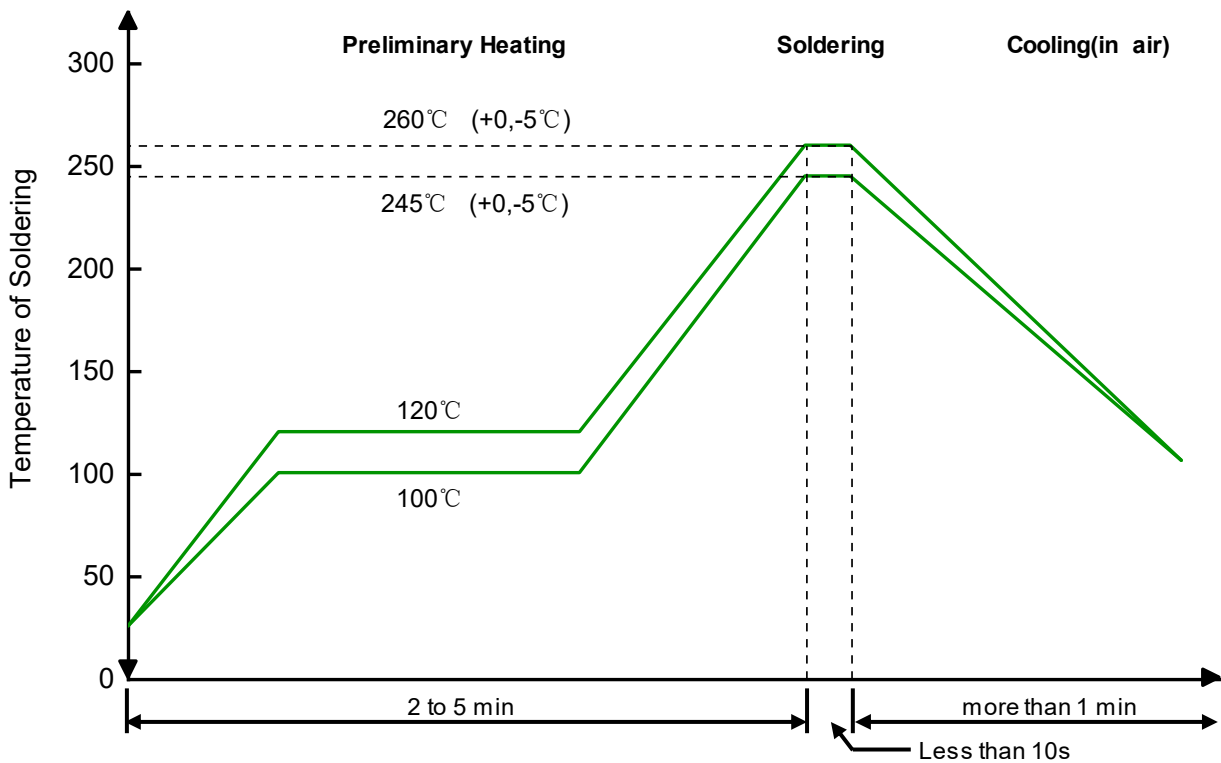

Fig 9. (IEC61000-4-2-8KV contact)

Solder Reflow Recommendation



Remark: Pb free for 260°C; Pb for 245°C.

PCB Design

For TVS diodes a low-ohmic and low-inductive path to chassis earth is absolutely mandatory in order to achieve good ESD protection. Novices in the area of ESD protection should take following suggestions to heart:

- Do not use stubs, but place the cathode of the TVS diode directly on the signal trace.
- Do not make false economies and save copper for the ground connection.
- Place via holes to ground as close as possible to the anode of the TVS diode.
- Use as many via holes as possible for the ground connection.
- Keep the length of via holes in mind! The longer the more inductance they will have.

Product dimension (DFN0603-2L)

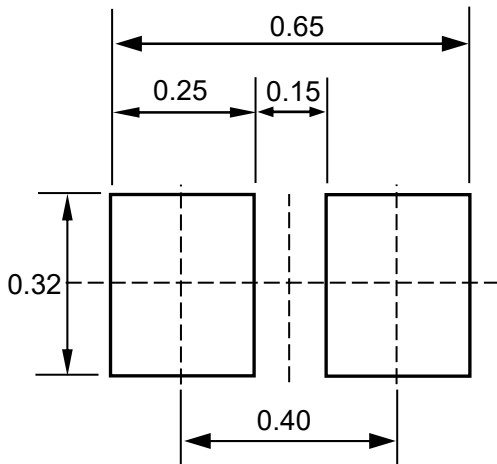
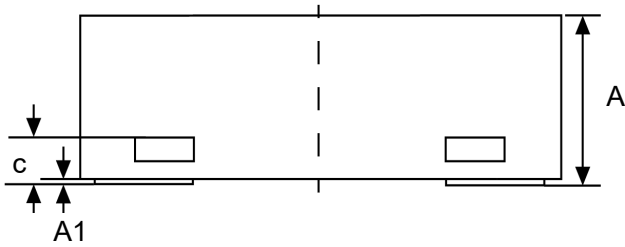
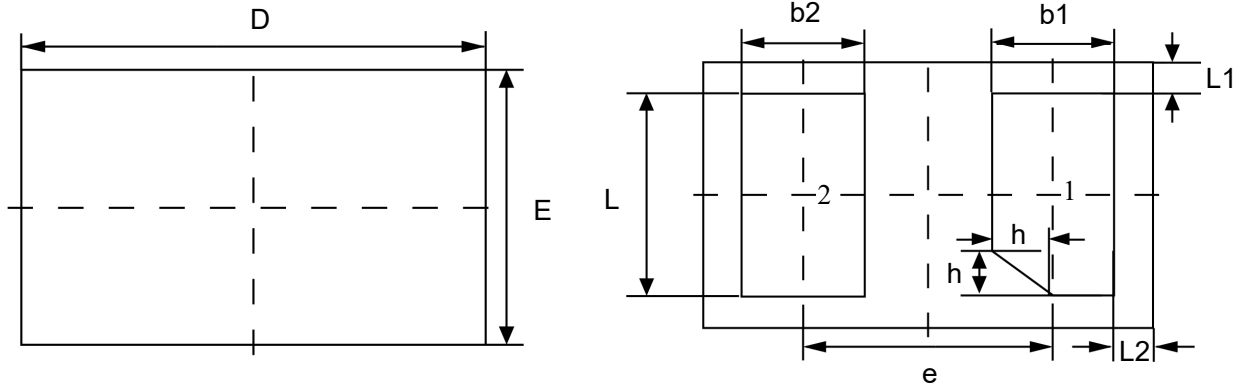

Dim	Millimeters		
	MIN	Typ.	MAX
A	0.25	0.30	0.32
A1	0	0.02	0.05
b1	0.13	0.18	0.23
b2	0.14	0.19	0.24
c	0.05	0.1	0.15
D	0.55	0.60	0.65
e	0.35BSC		
L1	0.025BSC		
L2	0.035BSC		
E	0.25	0.30	0.35
L	0.20	0.25	0.30
h	0	0.05	0.10

Unit: mm

Suggested PCB Layout

Ordering information

Device	Package	Reel	Shipping
PESDUC2XD5VB	DFN0603-2L (Pb-Free)	7"	12000 / Tape & Reel

Load with information

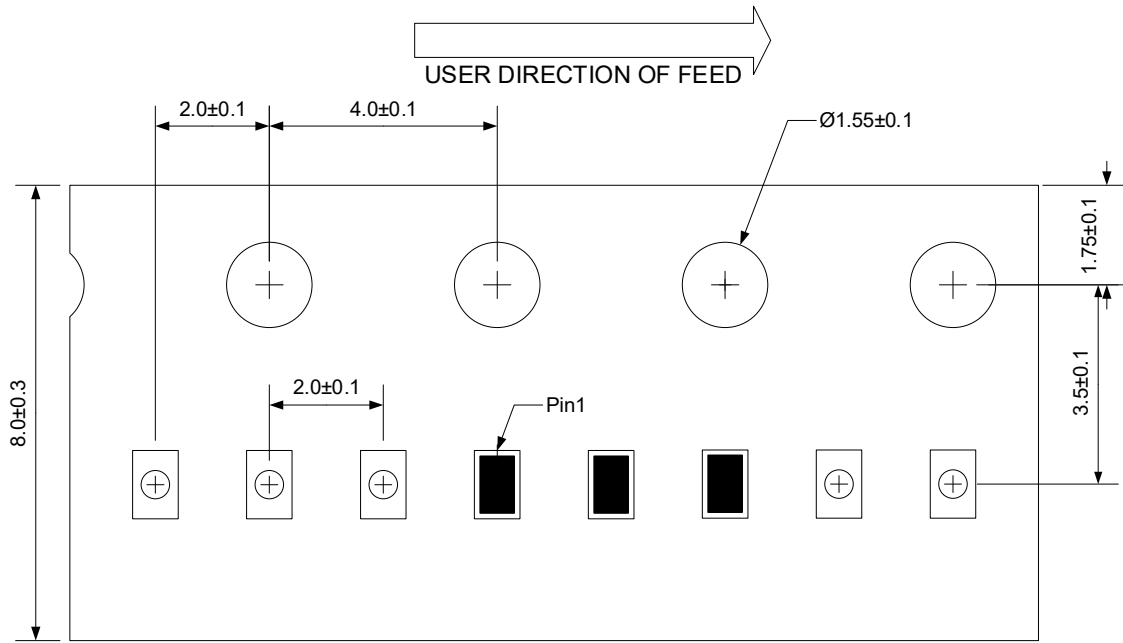

Unit:mm

**IMPORTANT NOTICE**

 and **Prisemi**<sup>®</sup> are registered trademarks of **Prisemi Electronics Co., Ltd** (Prisemi). Prisemi reserves the right to make changes without further notice to any products herein. Prisemi makes no warranty, representation or guarantee regarding the suitability of its products for any particular purpose, nor does Prisemi assume any liability arising out of the application or use of any product or circuit, and specifically disclaims any and all liability, including without limitation special, consequential or incidental damages. "Typical" parameters which may be provided in Prisemi data sheets and/or specifications can and do vary in different applications and actual performance may vary over time. All operating parameters, including "Typicals" must be validated for each customer application by customer's technical experts. Prisemi does not convey any license under its patent rights nor the rights of others. The products listed in this document are designed to be used with ordinary electronic equipment or devices, Should you intend to use these products with equipment or devices which require an extremely high level of reliability and the malfunction of which would directly endanger human life (such as medical instruments, aerospace machinery, nuclear-reactor controllers, fuel controllers and other safety devices), please be sure to consult with our sales representative in advance.

Website: <http://www.prisemi.com>

For additional information, please contact your local Sales Representative.

©Copyright 2009, Prisemi Electronics

 **Prisemi**<sup>®</sup> is a registered trademark of Prisemi Electronics.

All rights are reserved.