

Description

The PESDNC2XD4V5B protects sensitive semiconductor components from damage or upset due to electrostatic discharge (ESD) and other voltage induced transient events. They feature large cross-sectional area junctions for conducting high transient currents, offer desirable electrical characteristics for board level protection, such as fast response time, low operating voltage. It gives designer the flexibility to protect one bi-directional line in applications where arrays are not practical.

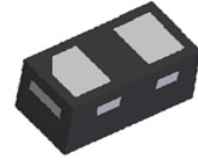

DFN0603-2L(Bottom View)

Feature

- 70W peak pulse power per line ($t_P = 8/20\mu s$)
- DFN0603-2L package
- Replacement for MLV(0201)
- Bidirectional configurations
- Response time is typically < 1ns
- Low clamping voltage
- RoHS compliant
- Transient protection for data lines to
IEC61000-4-2(ESD) $\pm 30KV$ (air), $\pm 30KV$ (contact);
IEC61000-4-4 (EFT) 40A (5/50ns)
IEC61000-4-5 (Surge) 8A (8/20us)

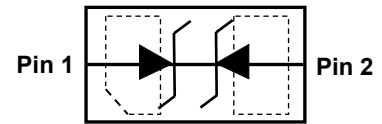

Circuit Diagram

Applications

- Cellular phones
- Portable devices
- Digital cameras
- Power supplies

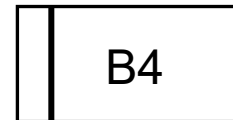

Marking (Top View)

Mechanical Characteristics

- Mounting position: Any
- Qualified max reflow temperature: 260°C
- Device meets MSL 1 requirements
- DFN0603-2L without plating

Electronics Parameter

Symbol	Parameter
V_{RWM}	Peak Reverse Working Voltage
I_R	Reverse Leakage Current @ V_{RWM}
V_{TRIG}	Reverse trigger Current
V_{HOLD}	Reverse holding voltage
I_T	Test Current
I_{PP}	Maximum Reverse Peak Pulse Current
V_C	Clamping Voltage @ I_{PP}
P_{PP}	Peak Pulse Power
C_J	Junction Capacitance

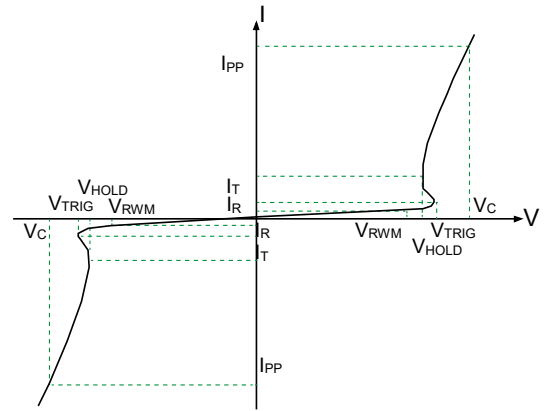

Electrical characteristics per line@25°C (unless otherwise specified)

Parameter	Symbol	Conditions	Min.	Typ.	Max.	Units
Peak Reverse Working Voltage	V_{RWM}				4.5	V
Reverse trigger voltage	V_{TRIG}	$I_{TRIG}=5\mu A$	4.7	5.6	6.5	V
Reverse holding voltage	V_{HOLD}	$I_{HOLD}=50mA$	4.6	5.1	6.0	
Reverse Leakage Current	I_R	$V_{RWM} = 4.5V$ $T=25^\circ C$			500	nA
Clamping Voltage	V_C	$I_{PP}=2A$		7.0	8.0	V
Clamping Voltage	V_C	$I_{PP}=8A$		8.0	9.0	V
Junction Capacitance	C_j	$V_R=0V$ $f = 1MHz$		16	20	pF

Absolute maximum rating@25°C

Rating	Symbol	Value	Units
Peak Pulse Power ($t_p=8/20\mu s$)	P_{pp}	60	W
Operating Temperature	T_J	-55 to 150	°C
Storage Temperature	T_{STG}	-55 to 150	°C

Typical Characteristics

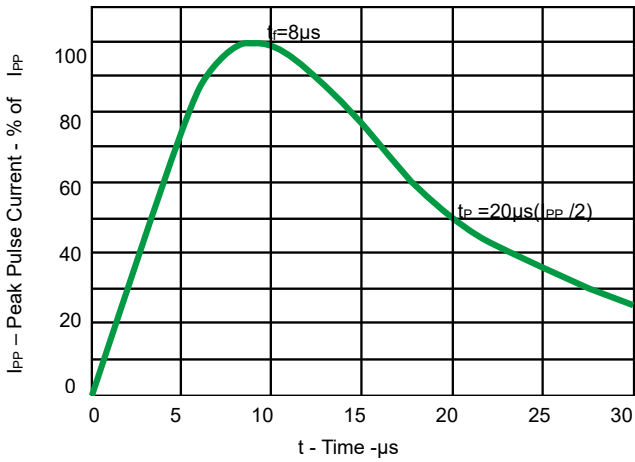

Fig 1. Pulse Waveform

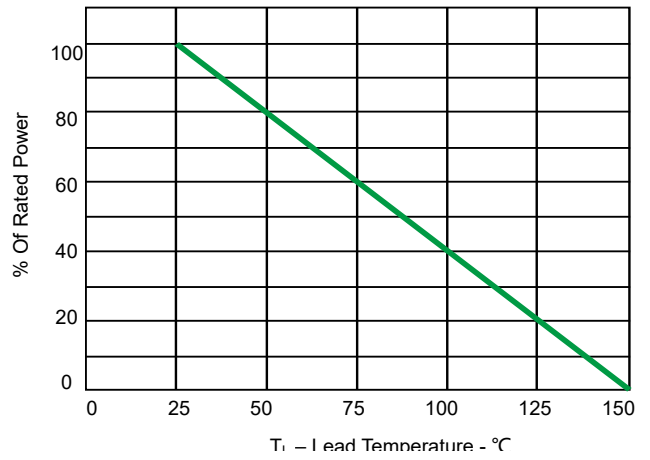

Fig 2. Power Derating Curve

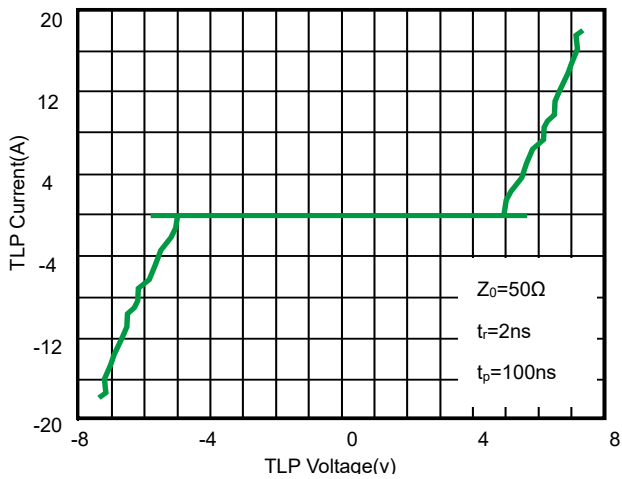

Fig 3. TLP Measurement

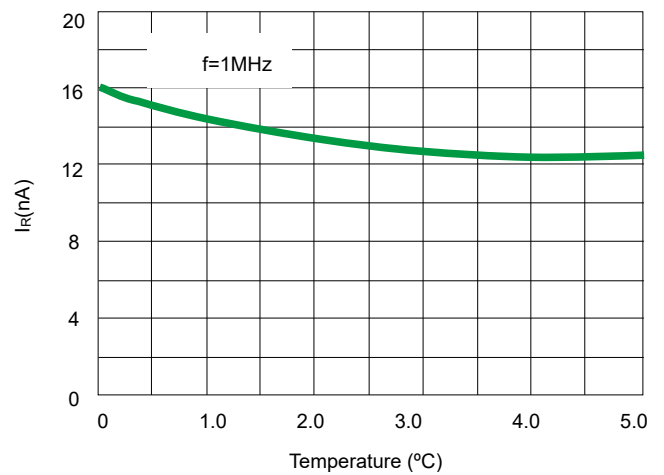

Fig 4. Typical Leakage Current vs. Temperature

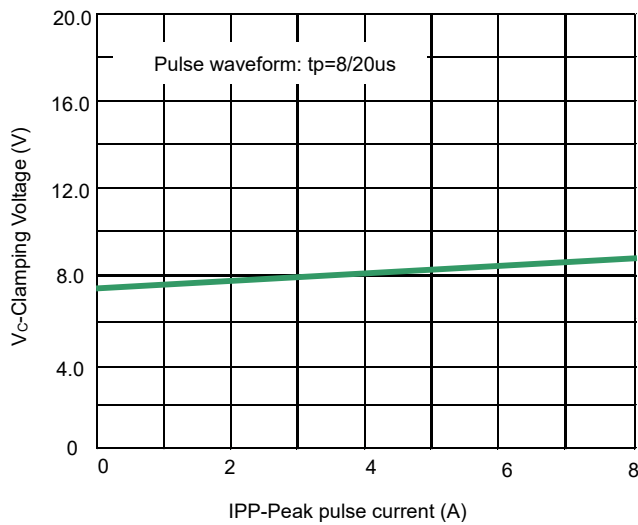

Fig 5. Clamping voltage vs. Peak pulse current

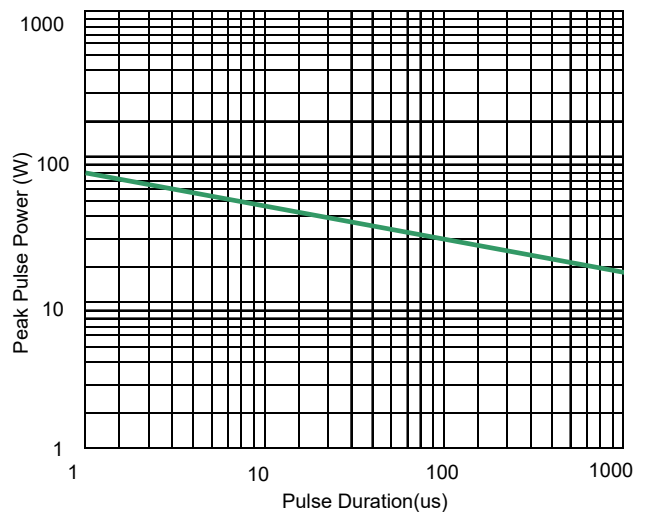

Fig 6. Non-Repetitive Peak Pulse Power vs. Pulse time

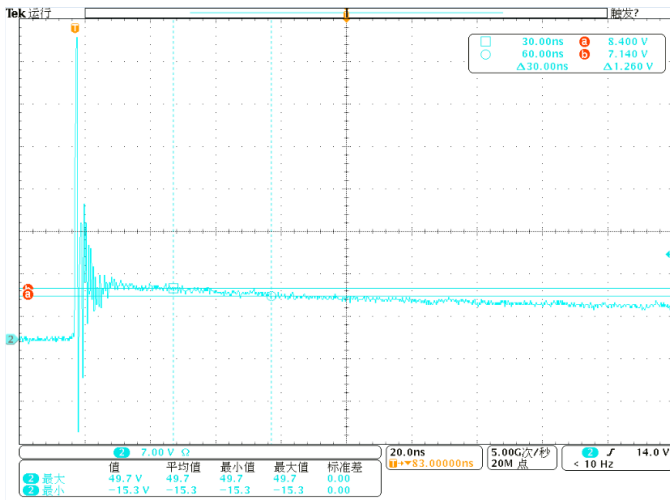

Fig 7. ESD clamping voltage (IEC61000-4-2 +8KV contact)

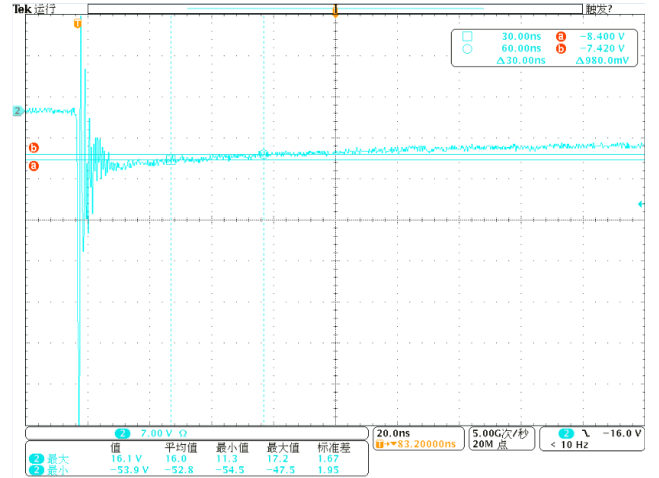
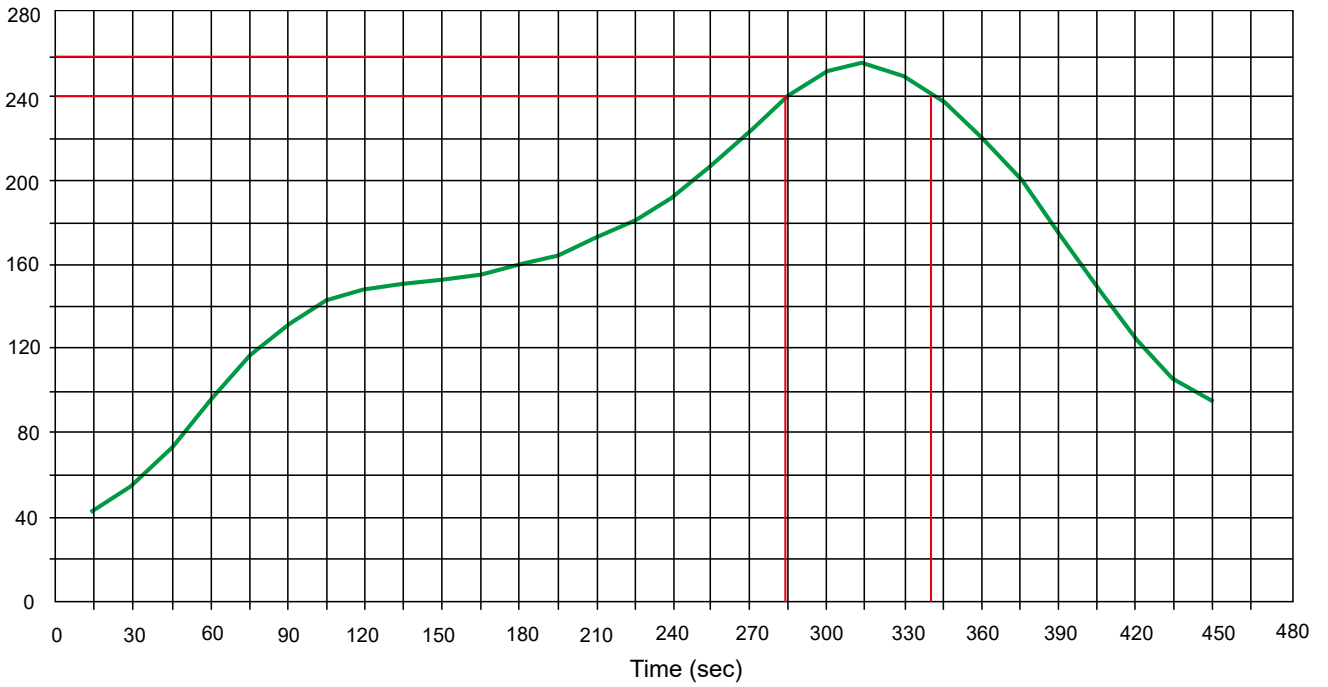

Fig 8. ESD clamping voltage (IEC61000-4-2 -8KV contact)

Solder Reflow Recommendation

Peak Temp=257°C, Ramp Rate=0.802deg. °C/sec



Product dimension (DFN0603-2L)

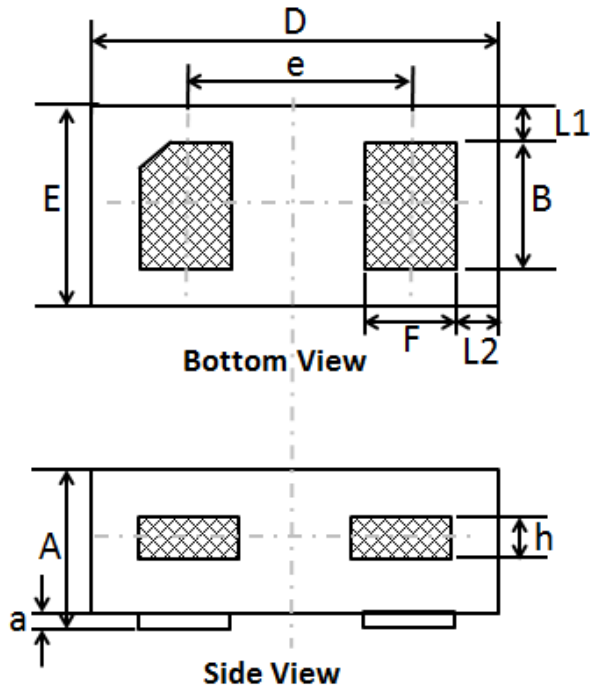

Dim	Millimeters		
	MIN	Typ.	MAX
A	0.26	0.30	0.35
B	0.20	0.25	0.30
D	0.55	0.60	0.65
E	0.25	0.30	0.35
F	0.13	0.18	0.23
L1	0.025BSC		
L2	0.035BSC		
a	0.00	0.02	0.05
e	0.35BSC		
h	0.05BSC		

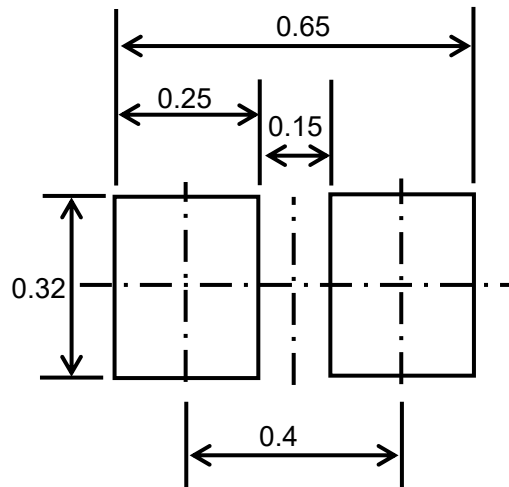

Suggested PCB Layout

Unit:mm

Ordering information

Device	Package	Reel	Shipping
PESDNC2XD4V5B	DFN0603-2L (Pb-Free)	7"	10000 / Tape & Reel

Load with information

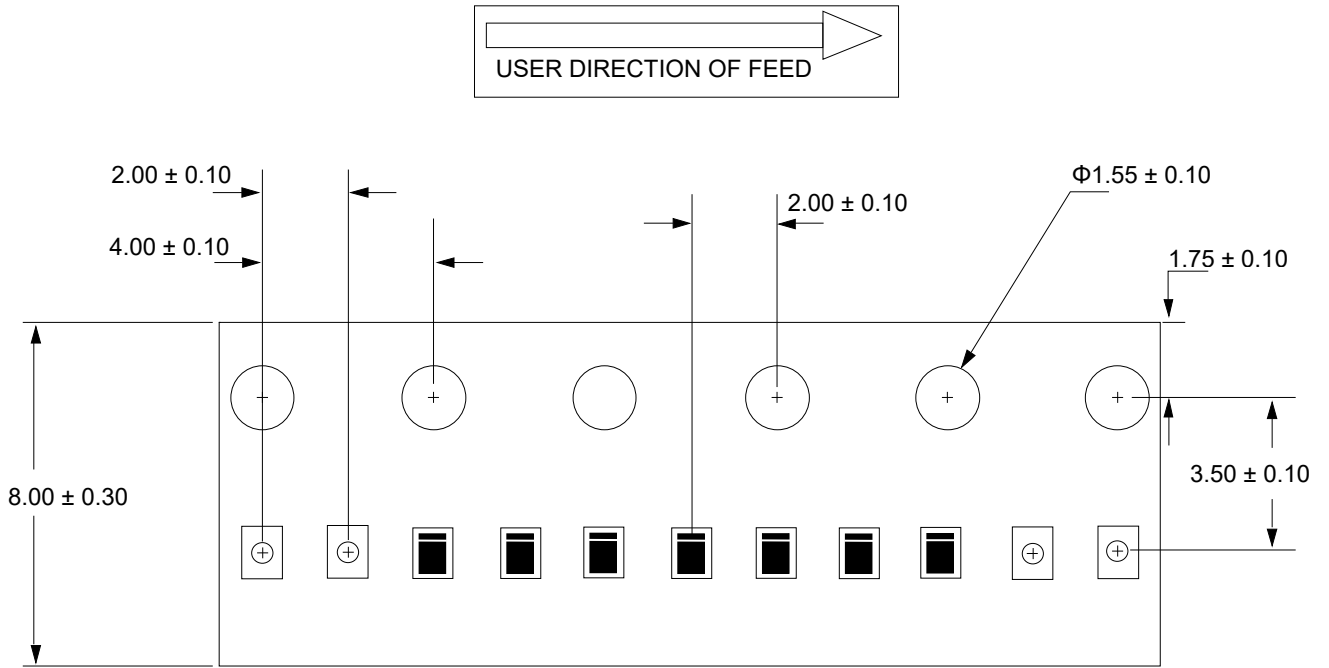

Unit: mm

IMPORTANT NOTICE

 and **Prisemi**[®] are registered trademarks of **Prisemi Electronics Co., Ltd (Prisemi)** ,Prisemi reserves the right to make changes without further notice to any products herein. Prisemi makes no warranty, representation or guarantee regarding the suitability of its products for any particular purpose, nor does Prisemi assume any liability arising out of the application or use of any product or circuit, and specifically disclaims any and all liability, including without limitation special, consequential or incidental damages. “Typical” parameters which may be provided in Prisemi data sheets and/or specifications can and do vary in different applications and actual performance may vary over time. All operating parameters, including “Typicals” must be validated for each customer application by customer’s technical experts. Prisemi does not convey any license under its patent rights nor the rights of others. The products listed in this document are designed to be used with ordinary electronic equipment or devices, Should you intend to use these products with equipment or devices which require an extremely high level of reliability and the malfunction of with would directly endanger human life (such as medical instruments, aerospace machinery, nuclear-reactor controllers, fuel controllers and other safety devices), please be sure to consult with our sales representative in advance.

Website: <http://www.prisemi.com>

For additional information, please contact your local Sales Representative.

©Copyright 2009, Prisemi Electronics

 **Prisemi**[®] is a registered trademark of Prisemi Electronics.

All rights are reserved.