

Uni-directional Normal Capacitance ESD Protector

Description

The PESDNC23T5VU is a Transient Voltage Suppressor Arrays that designed to protect components which are connected to data and transmission lines against electrostatic discharge(ESD), electrical fast transients(EFT), and lightning.

All pins are rated to withstand 30kV ESD pulses using the IEC61000-4-2 air discharge method.

Feature

- 500W peak pulse power ($t_p=8/20\mu s$) :
- SOT-23 Package
- Protects two Uni-directional lines
- Working voltage: 5V
- Low leakage current
- Low clamping voltage
- RoHS Compliant
- Transient Protection for High Speed Data Lines to IEC61000-4-2(ESD) $\pm 30kV$ (air), $\pm 30kV$ (Contact)

Applications

- Cellular handsets and accessories
- Portable electronics
- Control & monitoring systems
- Servers, notebooks, and desktop PCs
- Set-top box
- Communication systems

Mechanical Characteristics

- Lead finish:100% matte Sn(Tin)
- Mounting position: Any
- Qualified max reflow temperature:260°C
- Device meets MSL 1 requirements
- Pure tin plating: 7 ~ 17 μm
- Pin flatness: $\leq 3mil$

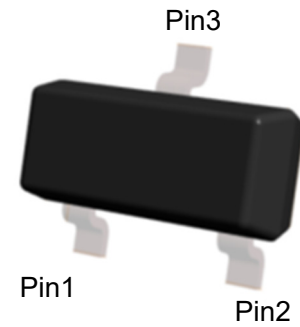

SOT-23(Top View)

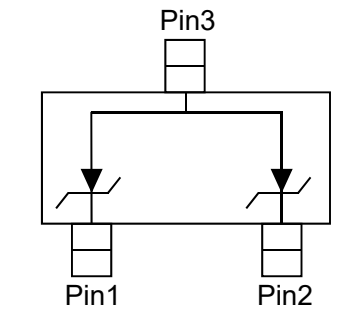

Circuit Diagram

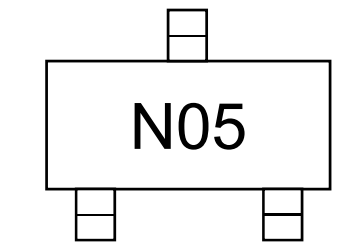

Marking (Top View)

Electronics Parameter

Symbol	Parameter
V_{RWM}	Peak Reverse Working Voltage
I_R	Reverse Leakage Current @ V_{RWM}
V_{BR}	Breakdown Voltage @ I_T
I_T	Test Current
I_{PP}	Maximum Reverse Peak Pulse Current
V_C	Clamping Voltage @ I_{PP}
P_{PP}	Peak Pulse Power
C_J	Junction Capacitance
I_F	Forward Current
V_F	Forward Voltage @ I_F

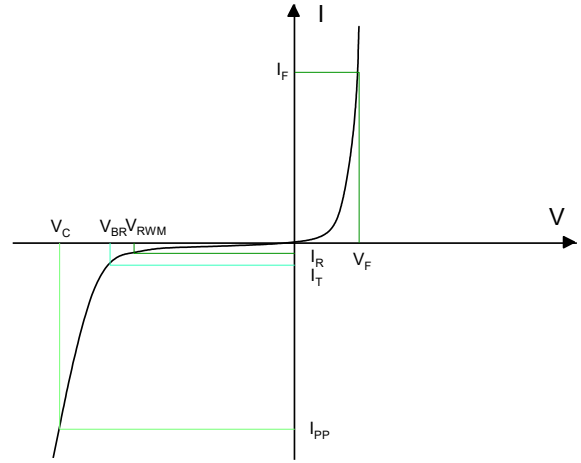

Electrical characteristics per line@25°C (unless otherwise specified)

Parameter	Symbol	Conditions	Min.	Typ.	Max.	Units
Peak Reverse Working Voltage	V_{RWM}	-	-	-	5.0	V
Breakdown Voltage	V_{BR}	$I_t = 1\text{mA}$	6.0	7.0	8.0	V
Reverse Leakage Current	I_R	$V_{RWM} = 5\text{V}$	-	-	1.0	μA
Clamping Voltage ¹⁾	V_C	TLP = 16A, $t_p = 100\text{ns}$	-	8.2	-	V
Dynamic resistance ¹⁾	R_{DYN}	-	-	0.01	-	Ω
Clamping Voltage ²⁾	V_C	$I_{PP} = 10\text{A}, t_p = 8/20\mu\text{s}$	-	8.0	10.0	V
		$I_{PP} = 45\text{A}, t_p = 8/20\mu\text{s}$	-	11.0	13.0	V
Junction Capacitance	C_J	$V_R = 0\text{V}, f = 1\text{MHz}$	-	150	-	pF

Notes:

1. TLP parameter: $Z_0=50\Omega$, $t_p=100\text{ns}$, $t_r=2\text{ns}$, averaging window from 60ns to 80ns. R_{DYN} is calculated from 4A to 16A.
2. Non-repetitive current pulse, according to IEC61000-4-5.

Absolute maximum rating@25°C

Rating	Symbol	Value	Units
Peak Pulse Power ($t_p = 8/20\mu\text{s}$)	P_{PP}	500	W
Peak Pulse Current ($t_p = 8/20\mu\text{s}$)	I_{PP}	45	A
Lead Soldering Temperature	T_L	260 (10 sec)	$^{\circ}\text{C}$
Junction and Storage Temperature Range	T_J, T_{STG}	-55~+150	$^{\circ}\text{C}$
ESD Protection-Contact Discharge	V_{ESD}	± 30	kV
ESD Protection-Air Discharge	V_{ESD}	± 30	kV

Typical Characteristics

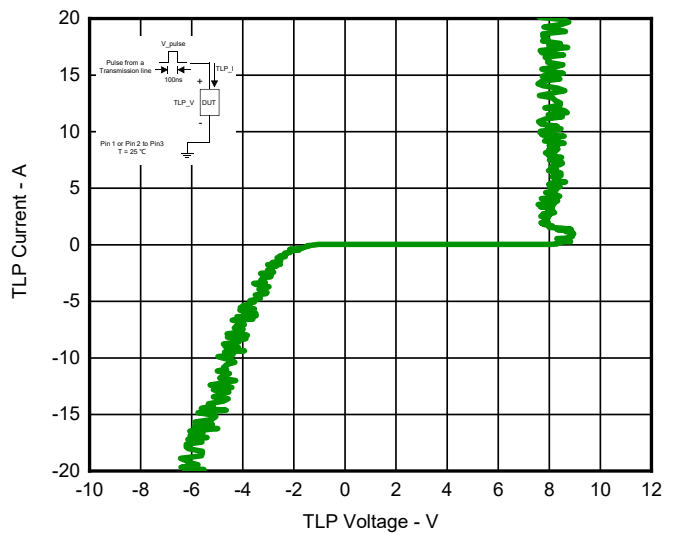
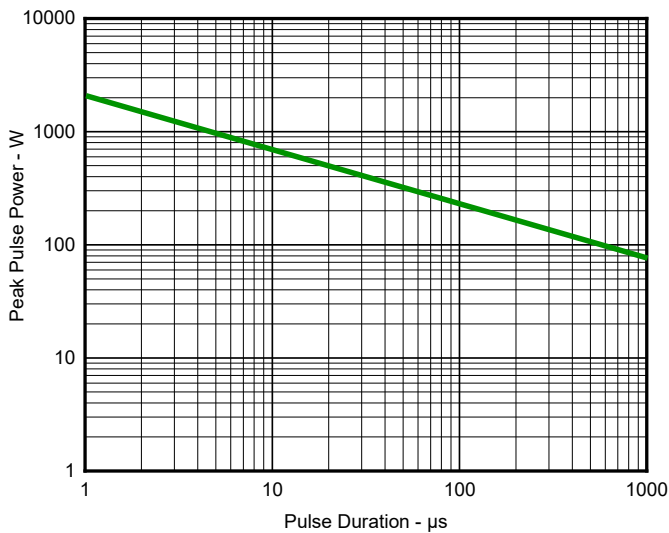
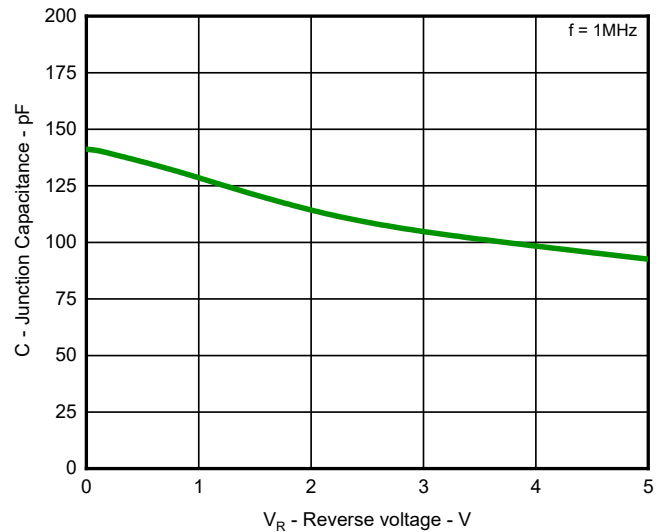
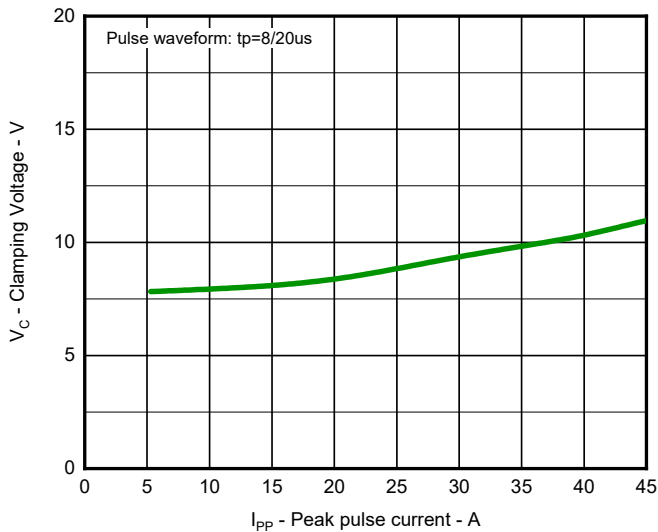
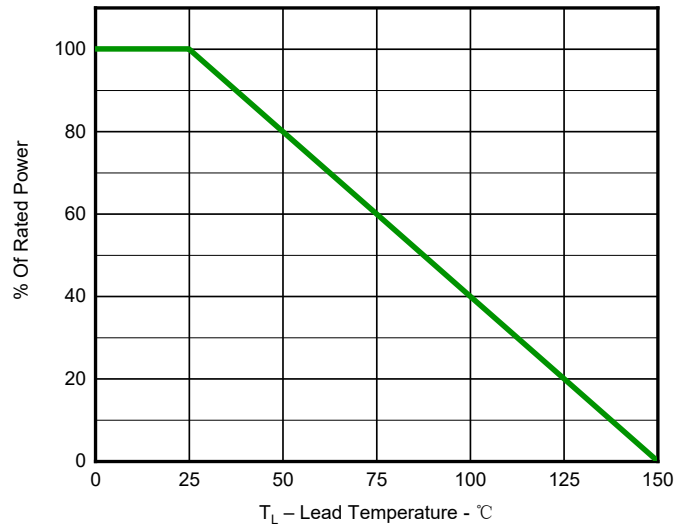
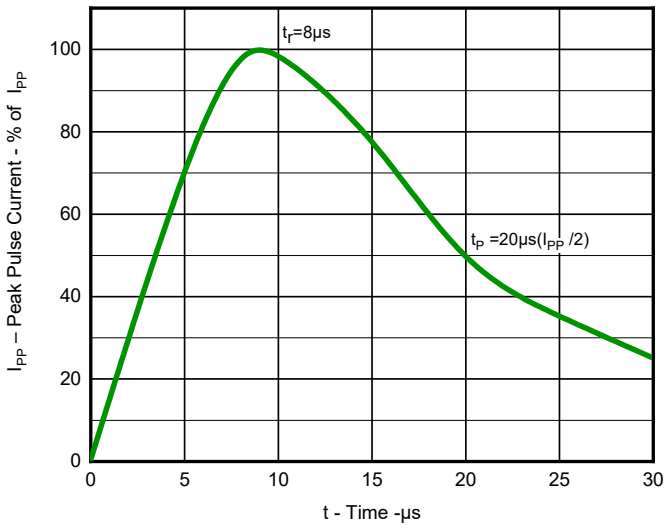

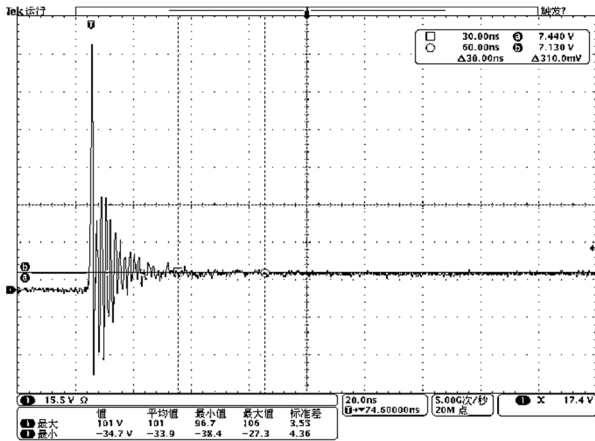

Fig 7. Clamping Voltage at IEC61000-4-2 +8kV Pulse Waveform

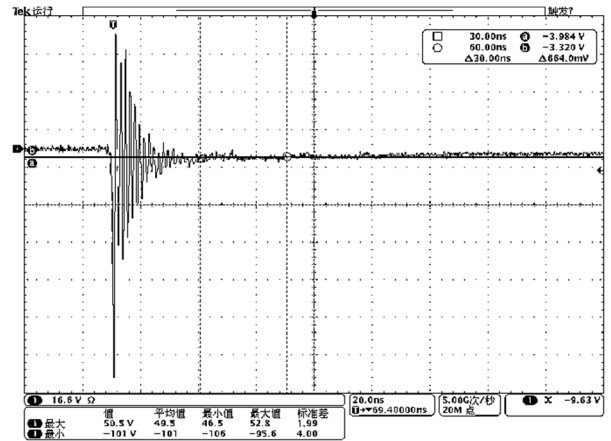
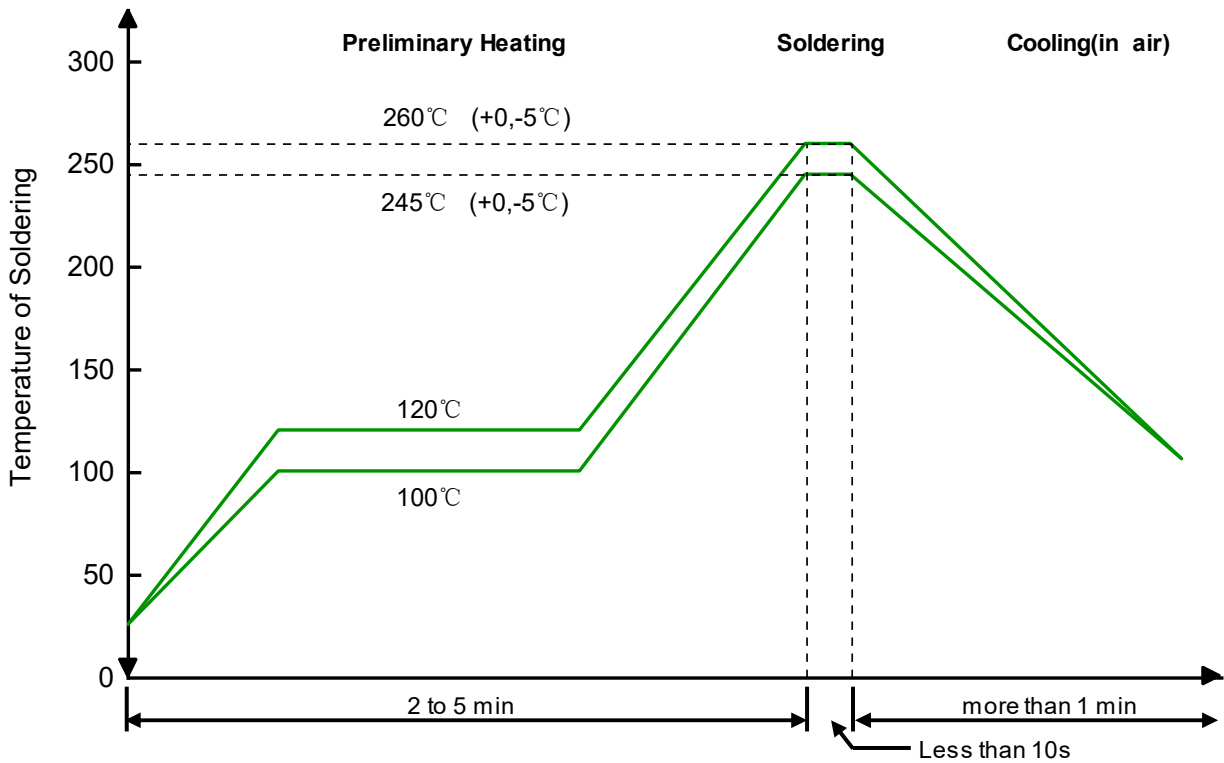

Fig 8. Clamping Voltage at IEC61000-4-2 -8kV Pulse Waveform

Solder Reflow Recommendation



Remark: Pb free for 260°C; Pb for 245°C.

PCB Design

For TVS diodes a low-ohmic and low-inductive path to chassis earth is absolutely mandatory in order to achieve good ESD protection. Novices in the area of ESD protection should take following suggestions to heart:

- Do not use stubs, but place the cathode of the TVS diode directly on the signal trace.
- Do not make false economies and save copper for the ground connection.
- Place via holes to ground as close as possible to the anode of the TVS diode.
- Use as many via holes as possible for the ground connection.
- Keep the length of via holes in mind! The longer the more inductance they will have.

Ordering information

Device	Package	Reel	Shipping
PESDNC23T5VU	SOT-23 (Pb-Free)	7"	3000 / Tape & Reel

Load with information

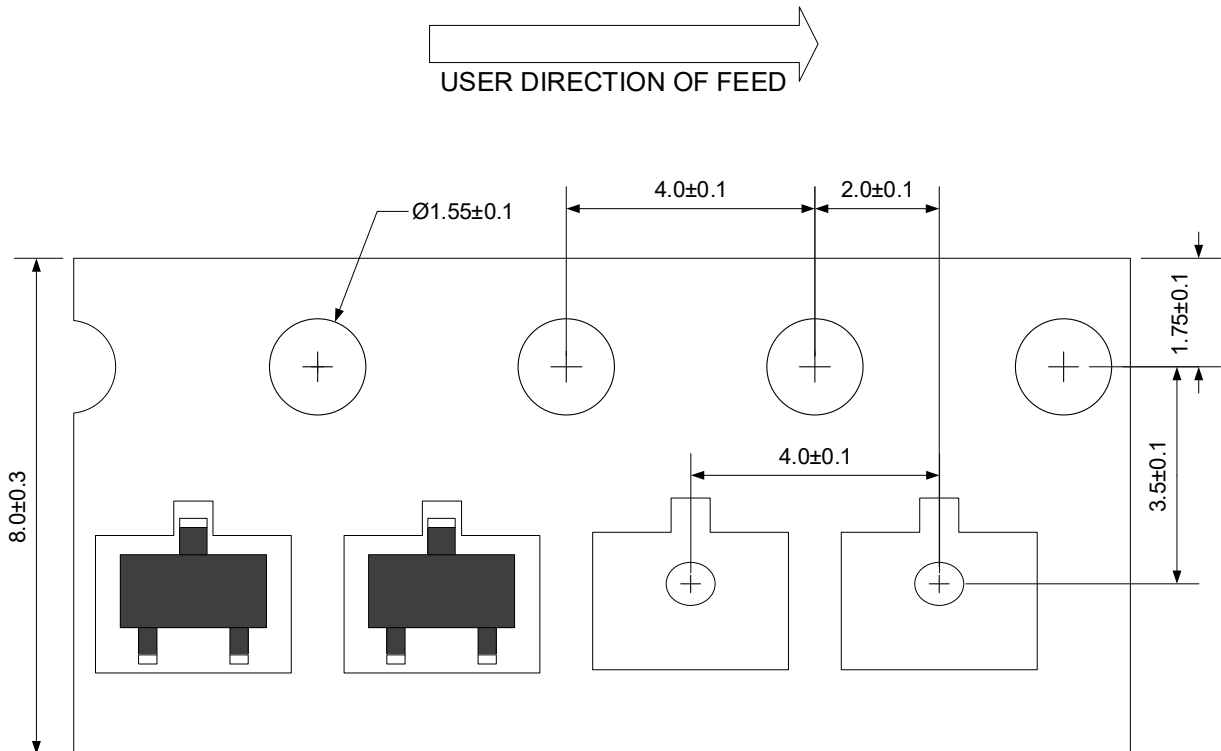

Unit:mm

Product dimension (SOT-23)

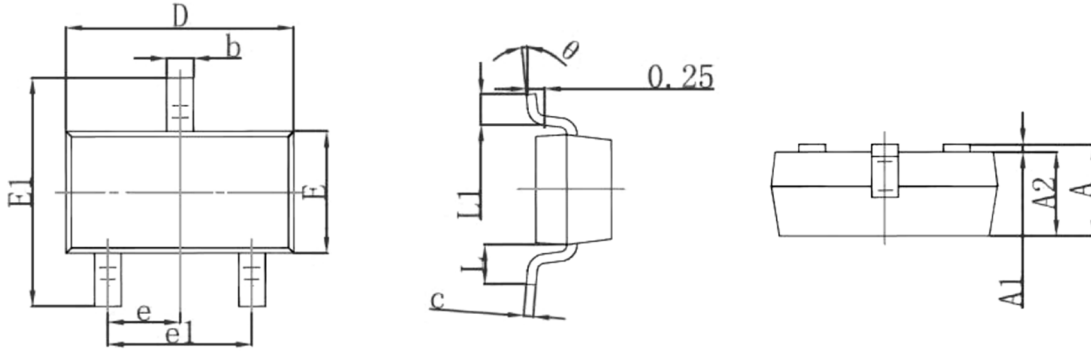

Dim	Millimeters		Inches	
	Min	Max	Min	Max
A	0.900	1.150	0.035	0.045
A1	0.000	0.100	0.000	0.004
A2	0.900	1.050	0.035	0.041
b	0.300	0.500	0.012	0.020
c	0.080	0.150	0.003	0.006
D	2.800	3.000	0.110	0.118
E	1.200	1.400	0.047	0.055
E1	2.250	2.550	0.089	0.100
e	0.950 Typ.		0.037 Typ.	
e1	1.800	2.000	0.071	0.079
L	0.550 Ref.		0.022 Ref.	
L1	0.300	0.500	0.012	0.020
θ	0°	8°	0°	8°

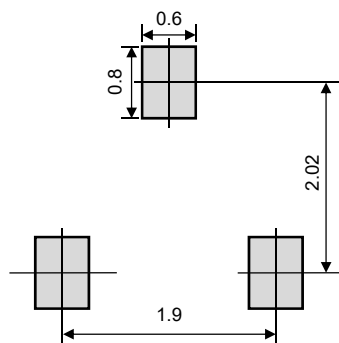

Unit:mm

Suggested PCB Layout

IMPORTANT NOTICE

 and **Prisemi**[®] are registered trademarks of **Prisemi Electronics Co., Ltd** (Prisemi), Prisemi reserves the right to make changes without further notice to any products herein. Prisemi makes no warranty, representation or guarantee regarding the suitability of its products for any particular purpose, nor does Prisemi assume any liability arising out of the application or use of any product or circuit, and specifically disclaims any and all liability, including without limitation special, consequential or incidental damages. "Typical" parameters which may be provided in Prisemi data sheets and/or specifications can and do vary in different applications and actual performance may vary over time. All operating parameters, including "Typicals" must be validated for each customer application by customer's technical experts. Prisemi does not convey any license under its patent rights nor the rights of others. The products listed in this document are designed to be used with ordinary electronic equipment or devices, Should you intend to use these products with equipment or devices which require an extremely high level of reliability and the malfunction of with would directly endanger human life (such as medical instruments, aerospace machinery, nuclear-reactor controllers, fuel controllers and other safety devices), please be sure to consult with our sales representative in advance.

Website: <http://www.prisemi.com>

For additional information, please contact your local Sales Representative.

©Copyright 2009, Prisemi Electronics

 **Prisemi**[®] is a registered trademark of Prisemi Electronics.

All rights are reserved.