

Description

The SMAF Series are designed specifically to protect sensitive electronic equipment from voltage transients induced by lightning and other transient voltage events.

Uni-directional

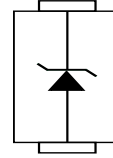

Bi-directional

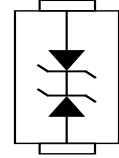

Feature

- For surface mounted applications in order to optimize board space.
- Low profile package
- Glass passivated junction
- Low inductance
- Plastic package has Underwriters Laboratory Flammability
- Excellent clamping capability
- Fast response time: typical less than 1.0 ps from 0V to V_{BR} min
- 400W peak pulse power capability at 10/1000us waveform, Repetition rate (duty cycle): 0.01%

Applications

TVS device are ideal for the protection of I/O interfaces, V_{CC} bus and other vulnerable circuits used in telecom, computer industrial and consumer electronic application

Absolute maximum rating@25°C

Rating	Symbol	Value	Units
Peak Pulse Power Dissipation on $T_A=25^\circ\text{C}$ (Note 1,2,4, Fig1)	P_{PPM}	400	W
Peak Forward Surge Current (Note 3, Fig 5)	I_{FSM}	40	A
Peak Pulse Current on 10/1000 us waveform (Note 1, Fig 2)	I_{PPM}	see Table 1	A
Maximum Junction capacitance at $V_R=100\text{mV}$, $f=1\text{MHz}$	C_J	390	pF
ESD Voltage per IEC6100-4-2 Contact Air	VESD1 VESD2	± 55 to ± 150	KV
Typical Thermal Resistance Junction to Ambient(Note 2)	$R_{\theta JA}$	150	$^\circ\text{C/W}$
Operating Junction Temperature and Storage Temperature Range	T_j, T_{stg}	-55 to +150	$^\circ\text{C}$

Electrical characteristics per line@25°C (unless otherwise specified)

Part Number (Uni)	Part Number (Bi)	Reverse Stand off Voltage V_R (V)	Breakdown Voltage $V_{BR}@I_T$ (V)		Test Current I_T (mA)	Maximum Reverse Leakage $I_R@V_{RWM}$ (uA)	Maximum Clamping Voltage V_C @ I_{PP} (V)	Maximum Peak Pulse Current I_{PP} (A)
			MIN	MAX				
P4SMAFJ5.0A	P4SMAFJ5.0CA	5.0	6.40	7.00	10	800	9.2	43.5
P4SMAFJ6.0A	P4SMAFJ6.0CA	6.0	6.67	7.37	10	800	10.3	38.8
P4SMAFJ6.5A	P4SMAFJ6.5CA	6.5	7.22	7.98	10	500	11.2	35.7
P4SMAFJ7.0A	P4SMAFJ7.0CA	7.0	7.78	8.60	10	200	12.0	33.3
P4SMAFJ7.5A	P4SMAFJ7.5CA	7.5	8.33	9.21	1	100	12.9	31.0
P4SMAFJ8.0A	P4SMAFJ8.0CA	8.0	8.89	9.83	1	50	13.6	29.4
P4SMAFJ8.5A	P4SMAFJ8.5CA	8.5	9.44	10.82	1	10	14.4	27.7
P4SMAFJ9.0A	P4SMAFJ9.0CA	9.0	10	11.5	1	5	15.4	26
P4SMAFJ10A	P4SMAFJ10CA	10	11.1	12.8	1	5	17	23.5
P4SMAFJ11A	P4SMAFJ11CA	11	12.2	14	1	1	18.2	22
P4SMAFJ12A	P4SMAFJ12CA	12	13.3	15.3	1	1	19.9	20.1
P4SMAFJ13A	P4SMAFJ13CA	13	14.4	16.5	1	1	21.5	18.6
P4SMAFJ14A	P4SMAFJ14CA	14	15.6	17.9	1	1	23.2	17.2
P4SMAFJ15A	P4SMAFJ15CA	15	16.7	19.2	1	1	24.4	16.4
P4SMAFJ16A	P4SMAFJ16CA	16	17.8	20.5	1	1	26	15.3
P4SMAFJ17A	P4SMAFJ17CA	17	18.9	21.7	1	1	27.6	14.5
P4SMAFJ18A	P4SMAFJ18CA	18	20	23.3	1	1	29.2	13.7
P4SMAFJ20A	P4SMAFJ20CA	20	22.2	25.5	1	1	32.4	12.3
P4SMAFJ22A	P4SMAFJ22CA	22	24.4	28	1	1	35.5	11.2
P4SMAFJ24A	P4SMAFJ24CA	24	26.7	30.7	1	1	38.9	10.3
P4SMAFJ26A	P4SMAFJ26CA	26	28.9	33.2	1	1	42.1	9.5
P4SMAFJ28A	P4SMAFJ28CA	28	31.1	35.8	1	1	45.4	8.8
P4SMAFJ30A	P4SMAFJ30CA	30	33.3	38.3	1	1	48.4	8.3
P4SMAFJ33A	P4SMAFJ33CA	33	36.7	42.2	1	1	53.3	7.5
P4SMAFJ36A	P4SMAFJ36CA	36	40	46	1	1	58.1	6.9
P4SMAFJ40A	P4SMAFJ40CA	40	44.4	51.1	1	1	64.5	6.2
P4SMAFJ43A	P4SMAFJ43CA	43	47.8	54.9	1	1	69.4	5.7
P4SMAFJ45A	P4SMAFJ45CA	45	50	57.5	1	1	72.7	5.5
P4SMAFJ48A	P4SMAFJ48CA	48	53.3	61.3	1	1	77.4	5.2
P4SMAFJ51A	P4SMAFJ51CA	51	56.7	65.2	1	1	82.4	4.9
P4SMAFJ54A	P4SMAFJ54CA	54	60	69	1	1	87.1	4.6
P4SMAFJ58A	P4SMAFJ58CA	58	64.4	74.1	1	1	93.6	4.3

P4SMAFJ5.0A THRU P4SMAFJ440A

Part Number (Uni)	Part Number (Bi)	Reverse Stand off Voltage V_R (V)	Breakdown Voltage $V_{BR@I_T}$ (V)		Test Current I_T (mA)	Maximum Reverse Leakage $I_R@V_{RWM}$ (μ A)	Maximum Clamping Voltage V_C @ I_{PP} (V)	Maximum Peak Pulse Current I_{PP} (A)
			MIN	MAX				
P4SMAFJ60A	P4SMAFJ60CA	60	66.7	76.7	1	1	96.8	4.1
P4SMAFJ64A	P4SMAFJ64CA	64	71.1	81.8	1	1	103	3.9
P4SMAFJ70A	P4SMAFJ70CA	70	77.8	89.5	1	1	113	3.5
P4SMAFJ75A	P4SMAFJ75CA	75	83.3	95.8	1	1	121	3.3
P4SMAFJ78A	P4SMAFJ78CA	78	86.7	99.7	1	1	126	2.2
P4SMAFJ85A	P4SMAFJ85CA	85	94.4	108	1	1	137	2.9
P4SMAFJ90A	P4SMAFJ90CA	90	100	116	1	1	146	2.7
P4SMAFJ100A	P4SMAFJ100CA	100	111	128	1	1	162	2.5
P4SMAFJ110A	P4SMAFJ110CA	110	122	141	1	1	177	2.3
P4SMAFJ120A	P4SMAFJ120CA	120	133	153	1	1	193	2
P4SMAFJ130A	P4SMAFJ130CA	130	144	166	1	1	209	1.9
P4SMAFJ150A	P4SMAFJ150CA	150	167	193	1	1	243	1.6
P4SMAFJ160A	P4SMAFJ160CA	160	178	205	1	1	259	1.5
P4SMAFJ170A	P4SMAFJ170CA	170	189	218	1	1	275	1.4
P4SMAFJ180A	P4SMAFJ180CA	180	201	222	1	1	292	1.3
P4SMAFJ200A	P4SMAFJ200CA	200	224	247	1	1	324	1.2
P4SMAFJ220A	P4SMAFJ220A	220	246	272	1	1	356	1.1
P4SMAFJ250A	P4SMAFJ250CA	250	279	309	1	1	405	1.0
P4SMAFJ300A	P4SMAFJ300CA	300	335	371	1	1	486	0.8
P4SMAFJ350A	P4SMAFJ350CA	350	391	432	1	1	567	0.7
P4SMAFJ400A	P4SMAFJ400CA	400	447	494	1	1	648	0.6
P4SMAFJ440A	P4SMAFJ440CA	440	492	543	1	1	713	0.6

For bidirectional type having V_{RWM} of 10 volts and less, the I_R limit is double.

For parts without A (V_{BR} is $\pm 10\%$ and V_C is 5% higher than with A parts)

Solder Reflow Recommendation

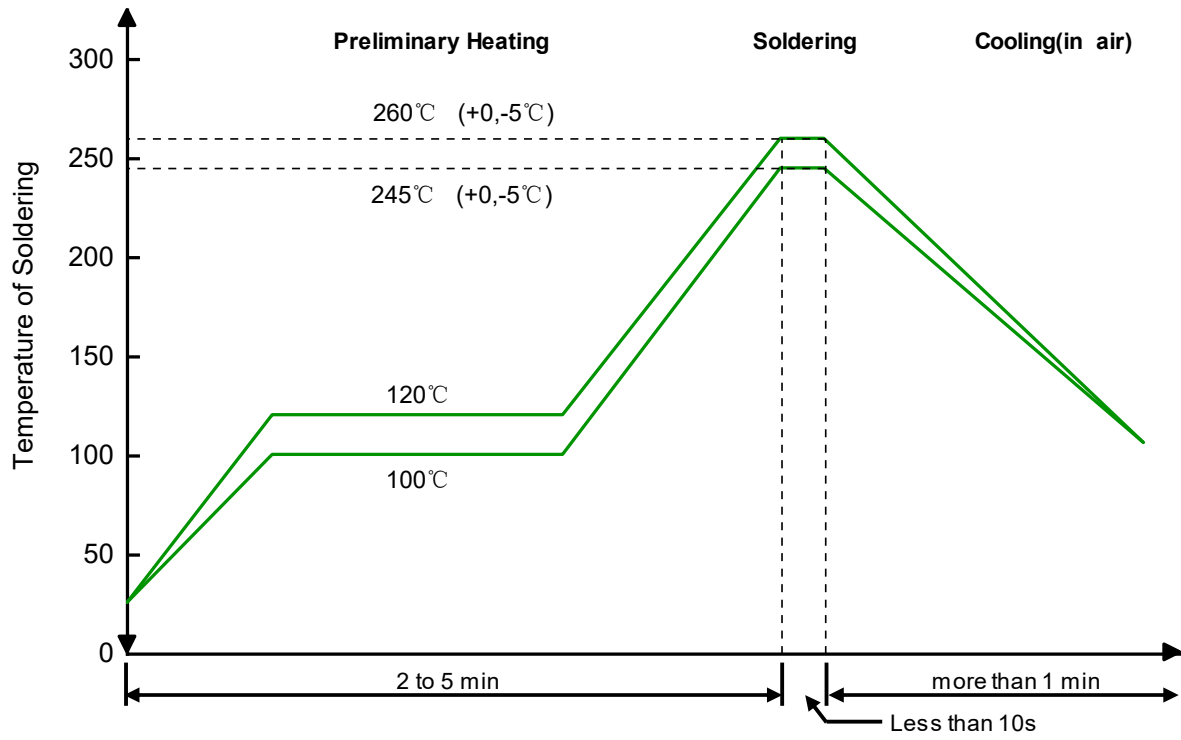

Remark: Pb free for 260°C; Pb for 245°C.

Product dimension (SMAF)

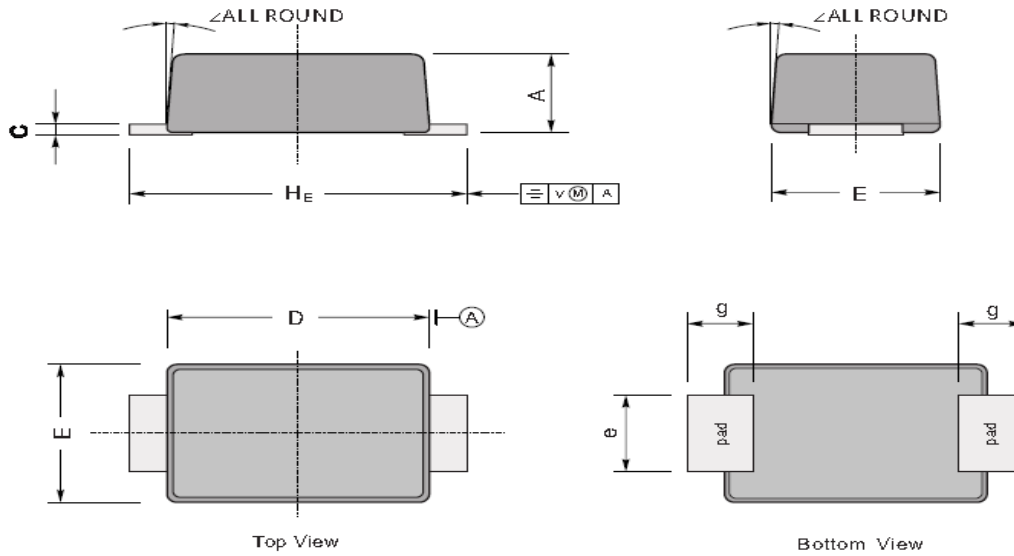

UNIT		A	C	D	E	e	g	H_E	\angle
mm	max	1.3	0.23	3.7	2.7	1.6	1.3	4.9	7°
	min	0.9	0.18	3.3	2.4	1.3	1.0	4.4	
mil	max	51	9.1	146	106	63	51	193	
	min	35	7.1	130	94	51	39	173	

The recommended mounting pad size

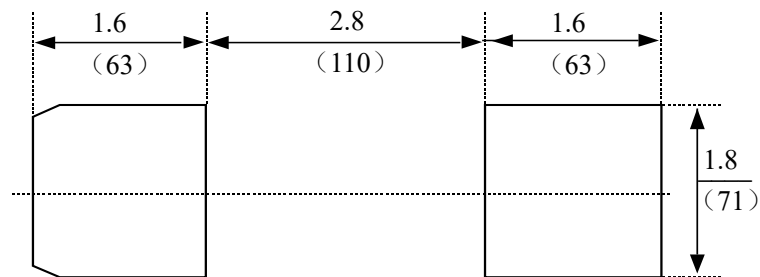

Unit: $\frac{\text{mm}}{\text{(mil)}}$

Ordering information

Device	Package	Shipping
P4SMAFJ5.0A-P4SMAFJ440CA	SMAF (Pb-Free)	3000/ Tape & Reel

IMPORTANT NOTICE

 and **Prisemi**[®] are registered trademarks of **Prisemi Electronics Co., Ltd** (Prisemi). Prisemi reserves the right to make changes without further notice to any products herein. Prisemi makes no warranty, representation or guarantee regarding the suitability of its products for any particular purpose, nor does Prisemi assume any liability arising out of the application or use of any product or circuit, and specifically disclaims any and all liability, including without limitation special, consequential or incidental damages. "Typical" parameters which may be provided in Prisemi data sheets and/or specifications can and do vary in different applications and actual performance may vary over time. All operating parameters, including "Typicals" must be validated for each customer application by customer's technical experts. Prisemi does not convey any license under its patent rights nor the rights of others. The products listed in this document are designed to be used with ordinary electronic equipment or devices. Should you intend to use these products with equipment or devices which require an extremely high level of reliability and the malfunction of which would directly endanger human life (such as medical instruments, aerospace machinery, nuclear-reactor controllers, fuel controllers and other safety devices), please be sure to consult with our sales representative in advance.

Website: <http://www.prisemi.com>

For additional information, please contact your local Sales Representative.

©Copyright 2009, Prisemi Electronics

 **Prisemi**[®] is a registered trademark of Prisemi Electronics.

All rights are reserved.