

Feature

- Built-in bias resistors enable the configuration of an inverter circuit without connecting external input resistors (see equivalent circuit).
- The bias resistors consist of thin-film resistors with complete isolation to allow negative biasing of the input. They also have the advantage of almost completely eliminating parasitic effects.
- Only the on/off conditions need to be set for operation, making the device design easy.

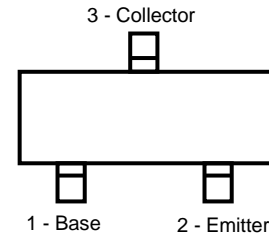
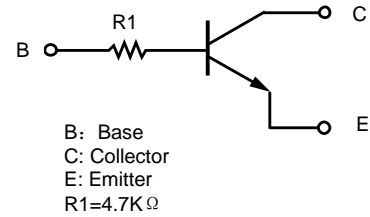

Top View

Applications

- Inverter
- Interface
- Driver

Mechanical Characteristics

- Lead finish:100% matte Sn(Tin)
- Mounting position: Any
- Qualified max reflow temperature:260°C
- Pure tin plating: 7 ~ 17 um
- Pin flatness : ≤3mil

Structure

NPN epitaxial planar silicon transistor (Resistor built-in type)

Electrical characteristics per line@25°C (unless otherwise specified)

Parameter	Symbol	Conditions	Min.	Typ.	Max.	Units
Collector-base breakdown voltage	BV_{CBO}	$I_C = 50\mu A$	50			V
Collector-emitter breakdown	BV_{CEO}	$I_C = 1mA$	50			V
Emitter-base breakdown voltage	BV_{EBO}	$I_E = 50\mu A$	5			V
Collector cutoff current	I_{CBO}	$V_{CB} = 50V$			0.5	μA
Emitter cutoff current	I_{EBO}	$V_{EB} = 4V$			0.5	μA
Collector-emitter saturation	$V_{CE(sat)}$	$I_C/I_B = 5mA/0.25mA$			0.3	V
DC current transfer ratio	h_{FE}	$I_C = 1mA, V_{CE} = 5V$	100	250	600	-
Input resistance	R_1	-	3.29	4.7	6.11	k Ω
Transition frequency	f_T	$V_{CE} = 10V, I_E = -5mA,$		250		MHz

Absolute maximum rating@25°C

Rating	Symbol	Value	Units
Collector-base voltage	V_{CBO}	50	V
Collector-emitter voltage	V_{CEO}	50	V
Emitter-base voltage	V_{EBO}	5	V
Collector current	I_C	100	mA
Collector power dissipation	P_C	150	mW
Junction temperature	T_j	150	°C
Storage temperature	T_{stg}	-55 to +150	°C

Typical Characteristics

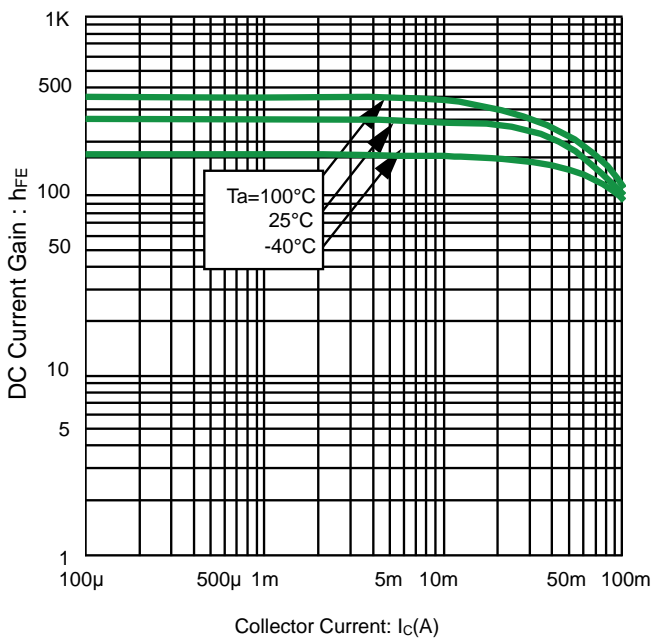

Fig 1.DC current gain vs. collector current @ $V_{CE}=5V$

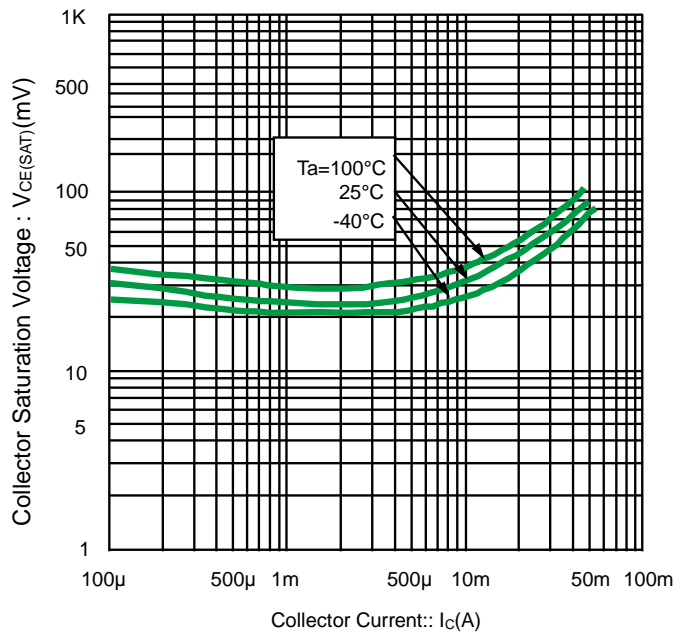
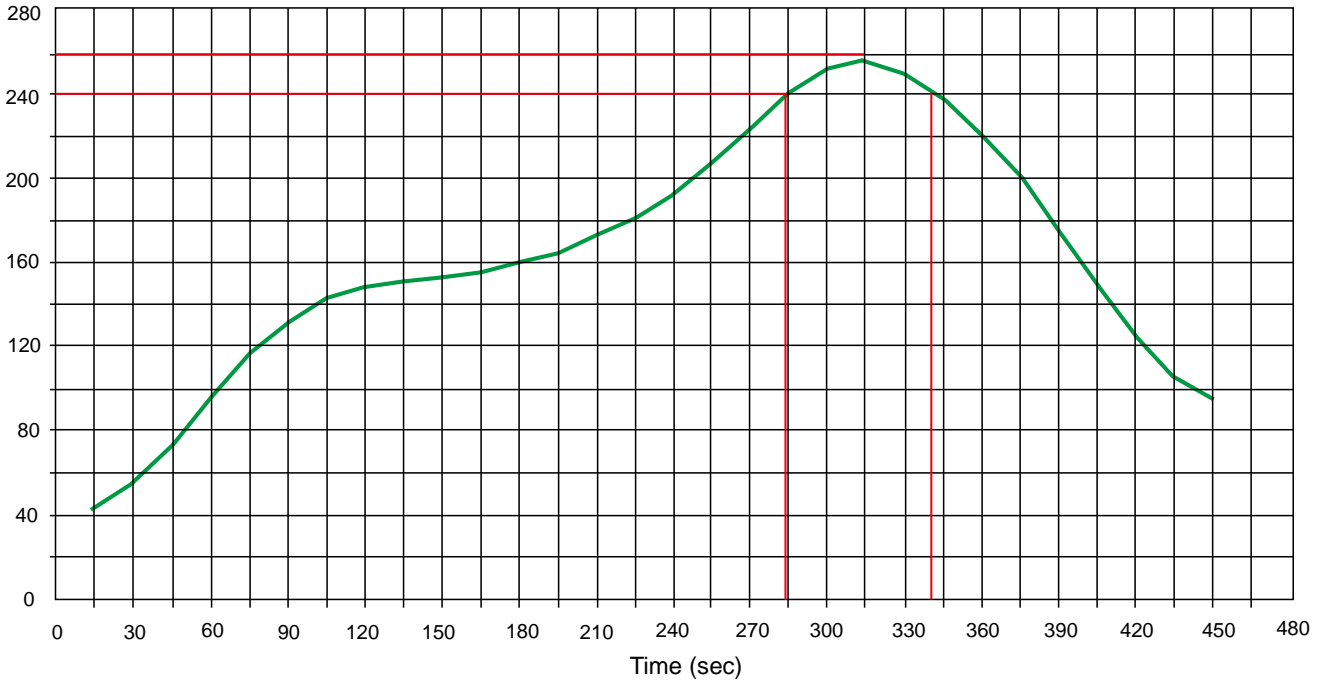

Fig 2.Collector-emitter saturation voltage vs. collector current @ $I_C/I_B=10$

Solder Reflow Recommendation

Peak Temp=257°C, Ramp Rate=0.802deg. °C/sec



Product dimension (SOT-723)

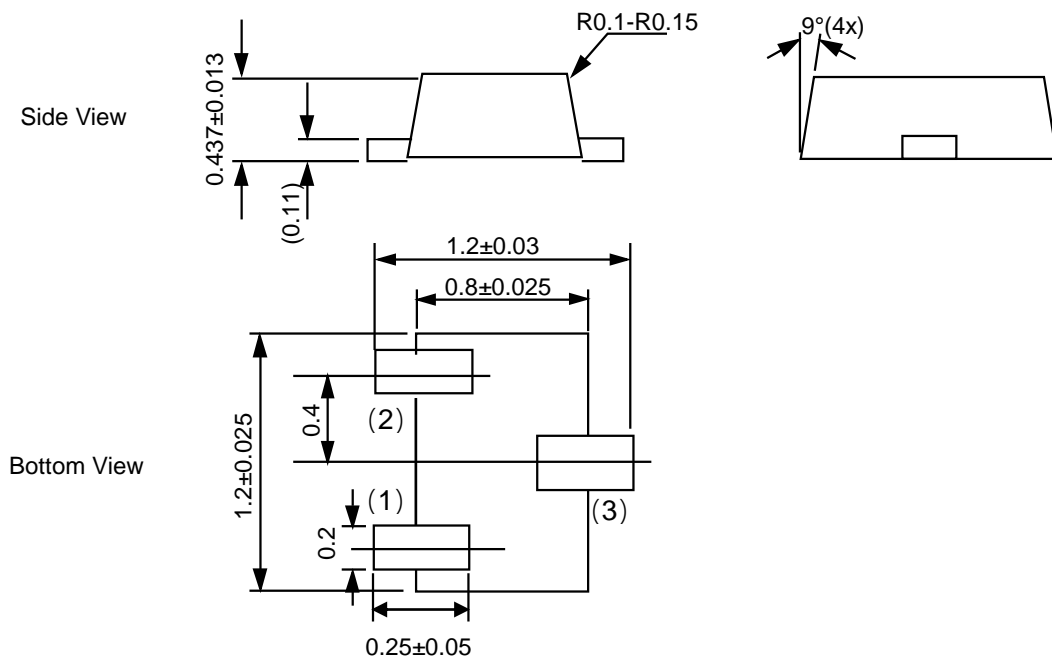

Unit : mm

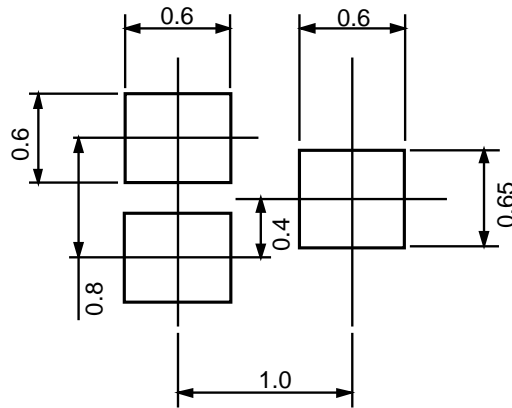

Unit: mm

Ordering information

Device	Package	Shipping
PDTC143TM	SOT-723 (Pb-Free)	8000 / Tape & Reel

IMPORTANT NOTICE

 and **Prisemi**[®] are registered trademarks of **Prisemi Electronics Co., Ltd (Prisemi)** ,Prisemi reserves the right to make changes without further notice to any products herein. Prisemi makes no warranty, representation or guarantee regarding the suitability of its products for any particular purpose, nor does Prisemi assume any liability arising out of the application or use of any product or circuit, and specifically disclaims any and all liability, including without limitation special, consequential or incidental damages. “Typical” parameters which may be provided in Prisemi data sheets and/or specifications can and do vary in different applications and actual performance may vary over time. All operating parameters, including “Typicals” must be validated for each customer application by customer’s technical experts. Prisemi does not convey any license under its patent rights nor the rights of others. The products listed in this document are designed to be used with ordinary electronic equipment or devices, Should you intend to use these products with equipment or devices which require an extremely high level of reliability and the malfunction of with would directly endanger human life (such as medical instruments, aerospace machinery, nuclear-reactor controllers, fuel controllers and other safety devices), please be sure to consult with our sales representative in advance.

Website: <http://www.prisemi.com>

For additional information, please contact your local Sales Representative.

©Copyright 2009, Prisemi Electronics

 **Prisemi**[®] is a registered trademark of Prisemi Electronics.

All rights are reserved.