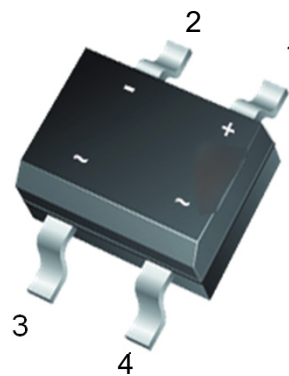
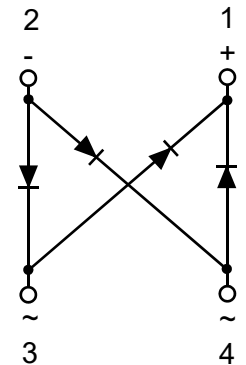

Surface Mount Glass Passivated Bridge Rectifier

Feature

- Glass Passivated Die Construction
- Low Forward Drop
- High Current Capability
- High Surge Current Capability
- Designed for Surface Mount Application

Top View

Circuit Diagram

Maximum Ratings and Electrical characteristics

Single-phase, half-wave, 60 Hz, resistive or inductive load .For capacitive load, derate current by 20%.

| Parameter | Symbol | MB1S | MB2S | MB4S | MB6S | MB8S | MB10S | Units |
|--|------------------------------------|---|------|------|------|------|-------|---------------------------|
| Peak repetitive Reverse Voltage Working Peak Reverse Voltage DC Blocking Voltage | V_{RRM} V_{RWM} V_R | 100 | 200 | 400 | 600 | 800 | 1000 | V |
| RMS Reverse Voltage | V_{RMS} | 70 | 140 | 280 | 420 | 560 | 700 | V |
| Average Rectified Output Current ¹⁾ @ $T_A=40^\circ\text{C}$ Average Rectified Output Current ²⁾ @ $T_A=40^\circ\text{C}$ | I_O | 0.5 0.8 | | | | | | A |
| Peak Forward Surge Current 8.3ms Single half sine-wave superimposed on rated load(JEDEC Method) | I_{FSM} | 35 | | | | | | A |
| I^2t Rating for Fusing($t<8.3\text{ms}$) | I^2t | 3.7 | | | | | | A^2s |
| Forward Voltage per element @ $I_F=0.4\text{A}$ | V_{FM} | 1.0 | | | | | | V |
| Peak Reverse Current at Rated DC Blocking Voltage | I_{RM} | $T_a = 25^\circ\text{C}$: 5.0 $T_a = 125^\circ\text{C}$: 100 | | | | | | μA |
| Typical Junction Capacitance ³⁾ | C_J | 13 | | | | | | pF |
| Typical Thermal Resistance ¹⁾ | $R_{\theta JA}$ $R_{\theta JL}$ | 85 20 | | | | | | $^\circ\text{C}/\text{W}$ |
| Operating and Storage Temperature Range | T_J, T_{STG} | -55~+150 | | | | | | $^\circ\text{C}$ |

Notes:

1. Mounted on glass epoxy PC board with 1.3mm² solder pad.
2. Mounted on aluminum substrate PC board with 1.3mm² solder pad.
3. Measured at 1.0MHz and applied reverse voltage of 4.0V D.C

Typical Characteristics

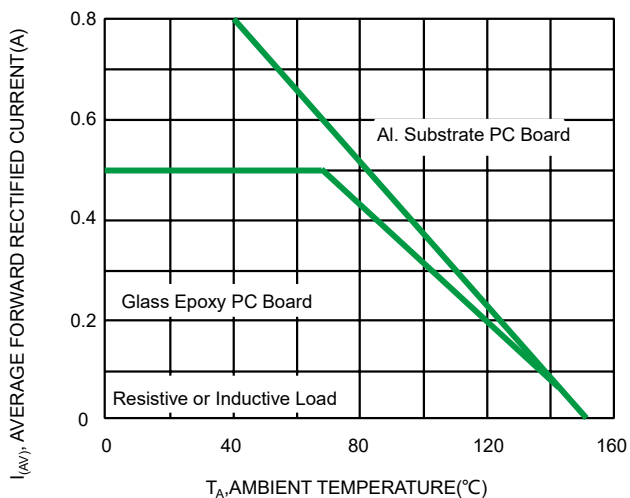

Fig 1. Output Current Derating Curve

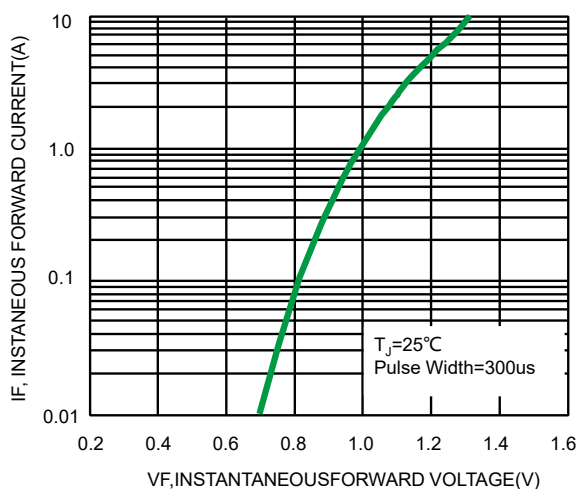

Fig 2. Typical Forward Characteristics

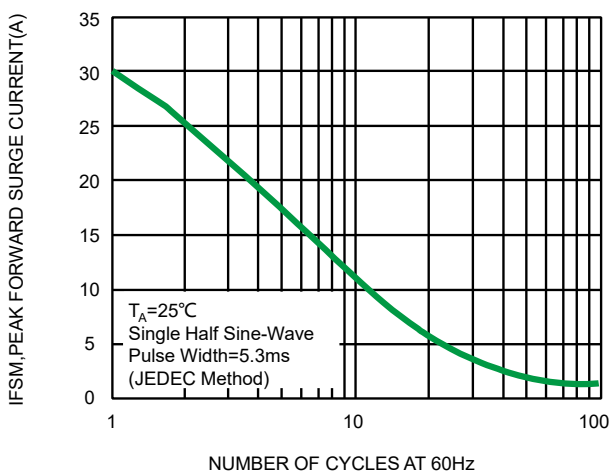

Fig 3. Maximum Peak Forward Surge Current

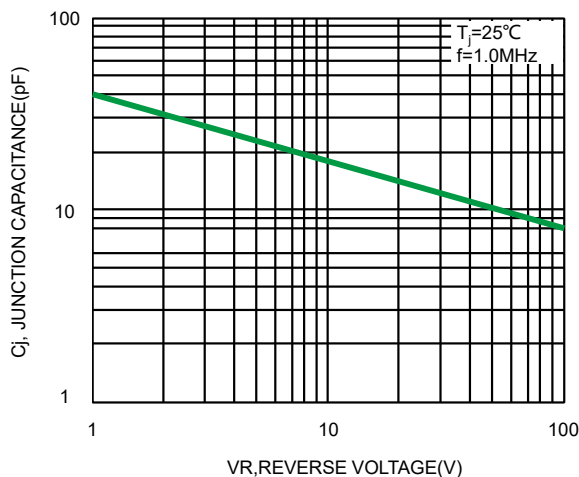

Fig 4. Typical Junction Capacitance

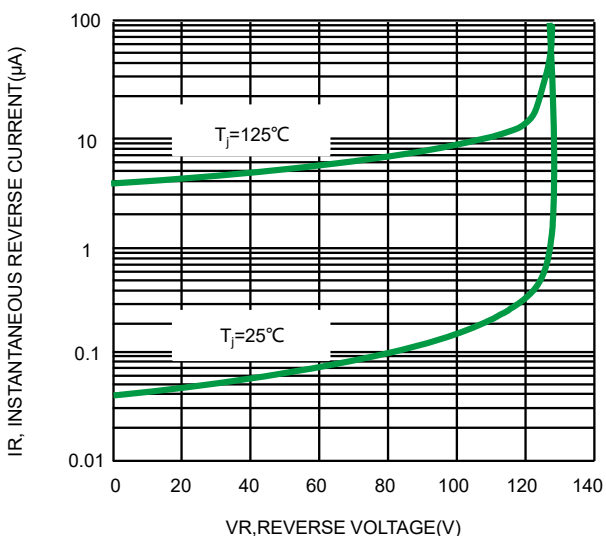
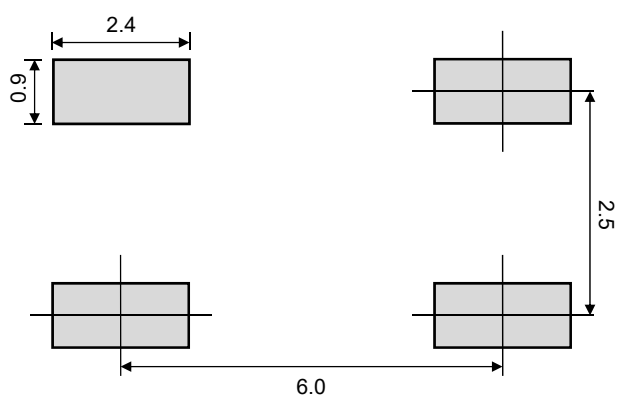
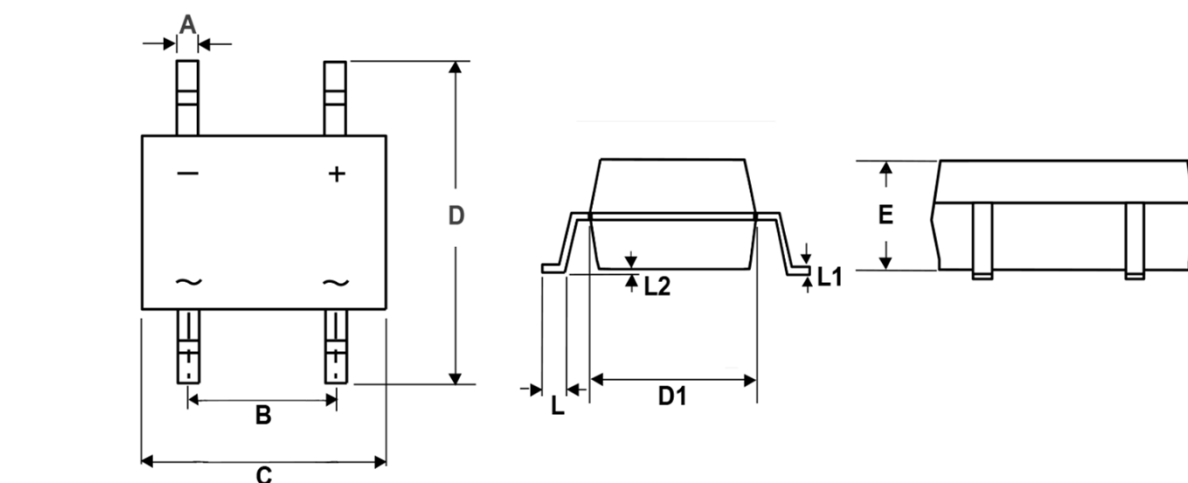

Fig 5. Typical Reverse Characteristics

Product dimension (MBS)



Suggested PCB Layout

Unit:mm

| Dim | Millimeters | | Inches | |
|-----|-------------|------|--------|-------|
| | Min | Max | Min | Max |
| A | 0.50 | 0.80 | 0.020 | 0.031 |
| B | 2.30 | 2.74 | 0.091 | 0.108 |
| C | 4.50 | 4.95 | 0.177 | 0.195 |
| D | 6.40 | 7.00 | 0.252 | 0.276 |
| D1 | 3.60 | 4.10 | 0.142 | 0.161 |
| E | 2.30 | 2.70 | 0.091 | 0.106 |
| L | 0.50 | 1.10 | 0.020 | 0.043 |
| L1 | 0.15 | 0.35 | 0.006 | 0.014 |
| L2 | 0.10 | 0.20 | 0.004 | 0.008 |

Ordering information

| Device | Package | Shipping |
|-------------|---------------|--------------------|
| MB1S ~MB10S | MBS (Pb-Free) | 3000 / Tape & Reel |

IMPORTANT NOTICE

 and **Prisemi**[®] are registered trademarks of **Prisemi Electronics Co., Ltd** (Prisemi), Prisemi reserves the right to make changes without further notice to any products herein. Prisemi makes no warranty, representation or guarantee regarding the suitability of its products for any particular purpose, nor does Prisemi assume any liability arising out of the application or use of any product or circuit, and specifically disclaims any and all liability, including without limitation special, consequential or incidental damages. "Typical" parameters which may be provided in Prisemi data sheets and/or specifications can and do vary in different applications and actual performance may vary over time. All operating parameters, including "Typicals" must be validated for each customer application by customer's technical experts. Prisemi does not convey any license under its patent rights nor the rights of others. The products listed in this document are designed to be used with ordinary electronic equipment or devices, Should you intend to use these products with equipment or devices which require an extremely high level of reliability and the malfunction of with would directly endanger human life (such as medical instruments, aerospace machinery, nuclear-reactor controllers, fuel controllers and other safety devices), please be sure to consult with our sales representative in advance.

Website: <http://www.prisemi.com>

For additional information, please contact your local Sales Representative.

©Copyright 2009, Prisemi Electronics

 **Prisemi**[®] is a registered trademark of Prisemi Electronics.

All rights are reserved.