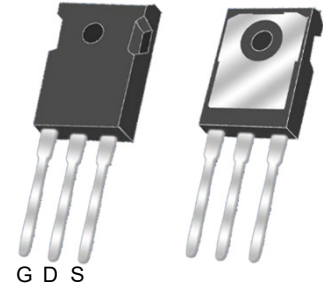

Description
MOSFET Product Summary

$V_{DS}(V)$	$R_{DS(on)}(m\Omega)$	$I_D(A)$
1200	75@ $V_{GS} = 18V$	38

TO-247-3L (Top View)
Feature

- High Blocking Voltage with Low On-Resistance
- High Speed Switching with Low Capacitances
- Avalanche Ruggednes

Applications

- Solar Inverters
- Switch Mode Power Supplies
- UPS
- Battery Chargers

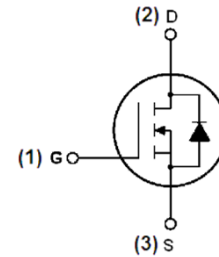
Schematic diagram
Absolute maximum rating@25°C

Parameter	Symbol	Rating	Unit
Drain-Source Voltage	V_{DS}	1200	V
Gate-Source Voltage	V_{GS}	-4/+18	V
Gate-Source Voltage (Absolute maximum values)	V_{GSmax}	-8/+22	V
Continuous Drain Current	I_D	$T_C=25^\circ C$	38
		$T_C=100^\circ C$	27
Pulsed Drain Current	I_{DM}	80	A
Power Dissipation	P_D	214	W
Avalanche Energy, Single Pulse	E_{AS}	600	mJ
Operating Junction Temperature	T_J	-55 to +175	°C
Storage Temperature	T_{STG}	-55 to +175	°C

Thermal Resistance

Parameter	Symbol	Min	Typ	Max	Unit
Thermal Resistance, Junction-to-Case	$R_{\theta JC}$	-	-	0.70	$^{\circ}\text{C}/\text{W}$
Thermal Resistance, Junction-to-Ambient	$R_{\theta JA}$	-	-	40	$^{\circ}\text{C}/\text{W}$

Electrical characteristics per line@25°C (unless otherwise specified)

Parameter	Symbol	Conditions	Min.	Typ.	Max.	Units
Statistic Characteristics						
Drain-Source Breakdown Voltage	BV_{DSS}	$V_{GS} = 0V, I_D = 100\mu\text{A}$	1200	-	-	V
Zero Gate Voltage Drain Current	I_{DSS}	$V_{DS} = 1200V, V_{GS} = 0V$ $T_C = 25^{\circ}\text{C}$	-	1.0	10	μA
		$V_{DS} = 1200V, V_{GS} = 0V$ $T_C = 175^{\circ}\text{C}$	-	5.0	-	
Gate-Body Leakage Current	I_{GSS}	$V_{GS} = 18V, V_{DS} = 0V$	-	-	100	nA
Gate Threshold Voltage	$V_{GS(th)}$	$V_{DS} = V_{GS}, I_D = 5\text{mA}$	2.3	2.8	3.6	V
Drain-Source On-State Resistance	$R_{DS(ON)}$	$V_{GS} = 18V, I_D = 20\text{A}$	-	75	85	m Ω
Transconductance	g_{fs}	$V_{DS} = 20V, I_D = 20\text{A}$	-	10	-	S
Dynamic Characteristics						
Input Capacitance	C_{iss}	$V_{DS} = 1000V, V_{GS} = 0V,$ $f = 1\text{MHz}, V_{AC} = 25\text{mV}$	-	920	-	pF
Output Capacitance	C_{oss}		-	57	-	
Reverse Transfer Capacitance	C_{rss}		-	3.9	-	
Turn-On Switching Energy	E_{on}	$V_{DS} = 800V, I_D = 20\text{A}$ $V_{GS} = -4/+15V,$ $R_G = 0\Omega, L = 120\mu\text{H}$	-	320	-	μJ
Turn-Off Switching Energy	E_{off}		-	49	-	
Turn-on Delay Time	$t_{d(on)}$	$V_{DS} = 800V, I_D = 20\text{A}$ $V_{GS} = -4/+15V,$ $R_G = 0\Omega, L = 120\mu\text{H}$	-	19	-	ns
Turn-on Rise Time	t_r		-	21	-	
Turn-Off Delay Time	$t_{d(off)}$		-	15	-	
Turn-Off Fall Time	t_f		-	17	-	
Total Gate Charge	Q_g	$V_{DS} = 800V, I_D = 20\text{A},$ $V_{GS} = -4/+18V$	-	40	-	nC
Gate-Source Charge	Q_{gs}		-	7.0	-	
Gate-Drain Charge	Q_{gd}		-	19	-	
Gate Resistance	R_G	$f = 1\text{MHz}, V_{AC} = 25\text{mV}$	-	1.5	-	Ω
Reverse Diode Characteristics						
Diode Forward Voltage	V_{SD}	$V_{GS} = -4V, I_{SD} = 10\text{A}$ $T_J = 25^{\circ}\text{C}$	-	4.2	-	V
		$V_{GS} = -4V, I_{SD} = 10\text{A}$ $T_J = 175^{\circ}\text{C}$	-	3.8	-	
Reverse Recovery Time	t_{rr}	$V_{DS} = 800V, V_{GS} = -4V,$ $I_{SD} = 20\text{A}, T_J = 150^{\circ}\text{C}$	-	41	-	ns
Reverse Recovery Charge	Q_{rr}	$di/dt = 700\text{A}/\mu\text{s}$	-	405	-	μC

Typical Characteristics

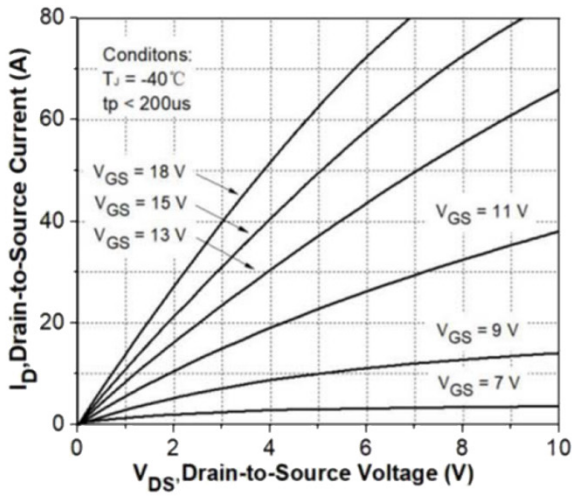

Fig 1. Output Characteristic ($T_J = -40^\circ\text{C}$)

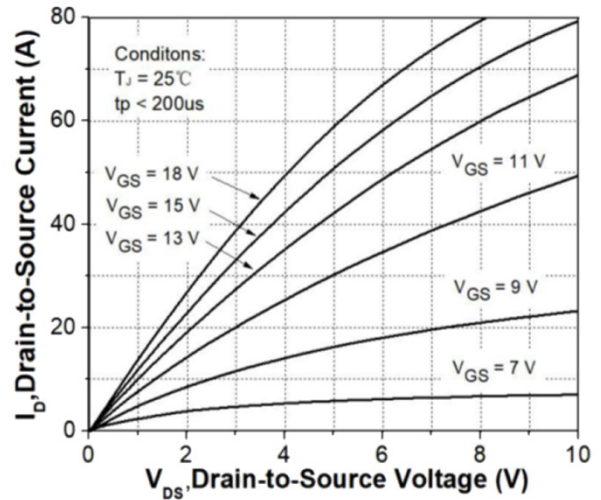

Fig 2. Output Characteristic ($T_J = 25^\circ\text{C}$)

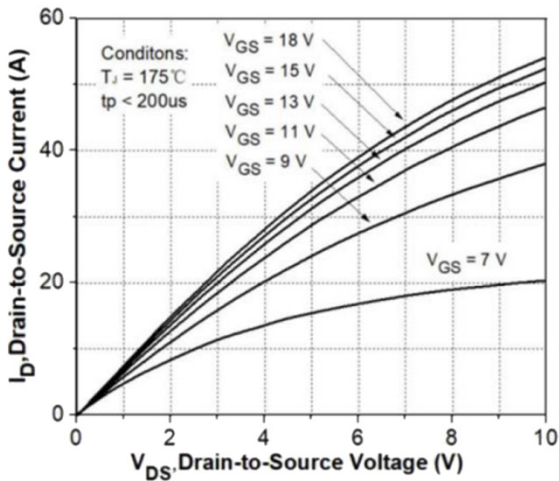

Fig 3. Output Characteristic ($T_J = 175^\circ\text{C}$)

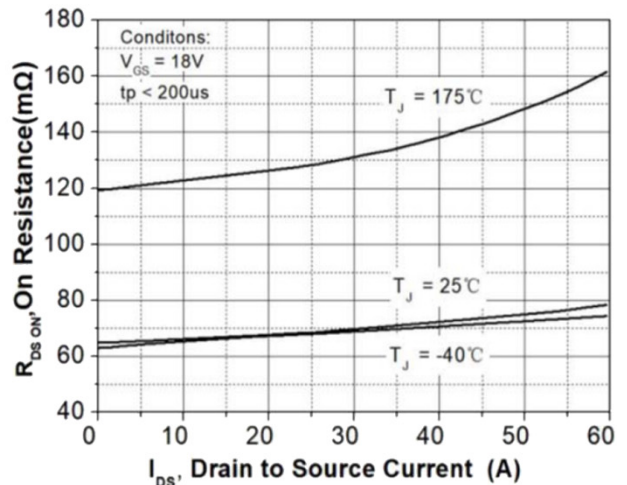

Fig 4: $R_{DS(on)}$ Vs I_{DS} Characteristic

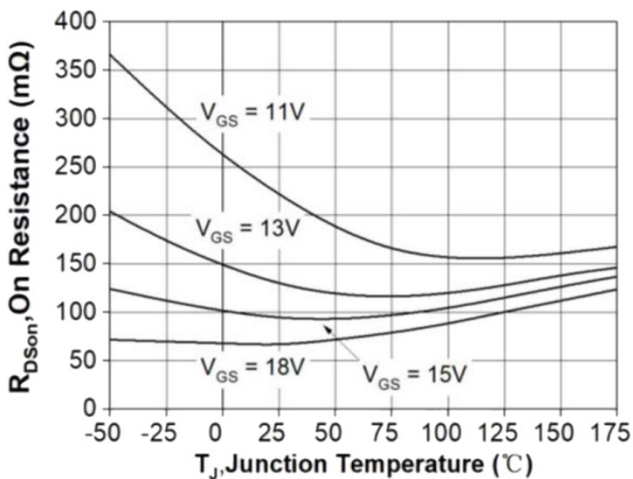

Fig 5: $R_{DS(on)}$ vs. Temperature

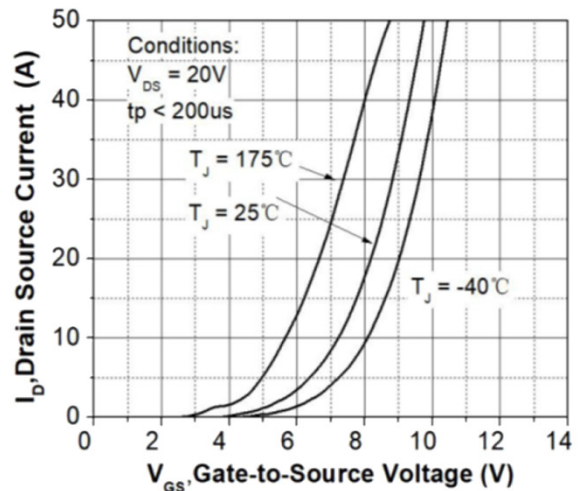

Fig 6: Transfer Characteristic

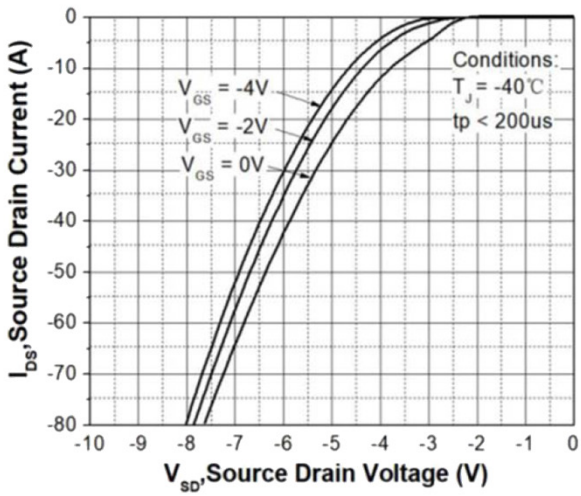

Fig 7: Body-diode Characteristic ($T_J = -40^\circ\text{C}$)

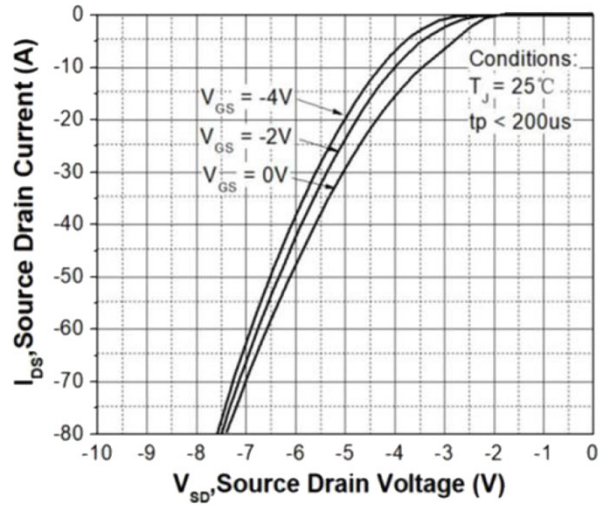

Fig 8: Body-diode Characteristic ($T_J = 25^\circ\text{C}$)

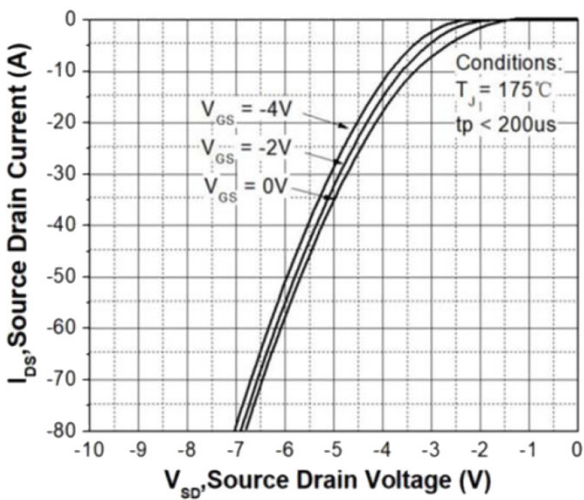

Fig 9: Body-diode Characteristic ($T_J = 175^\circ\text{C}$)

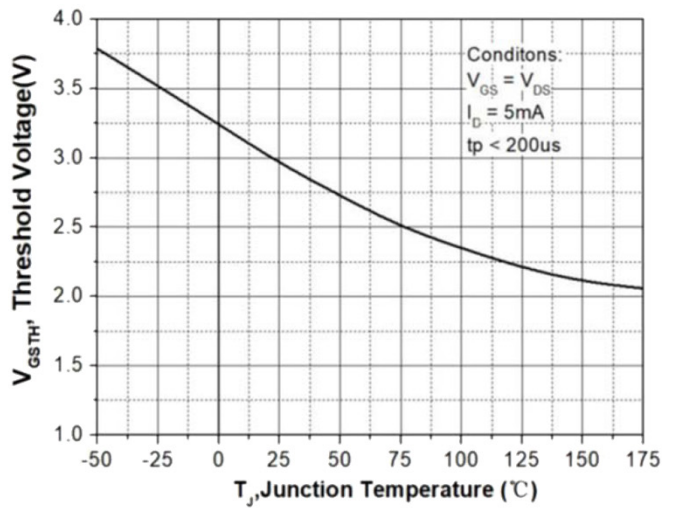

Fig 10: V_{TH} Vs T_J Temperature Characteristic

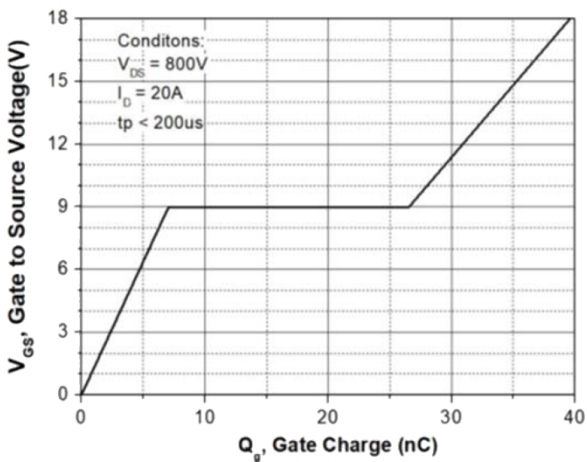

Fig 11: Gate Charge Characteristics

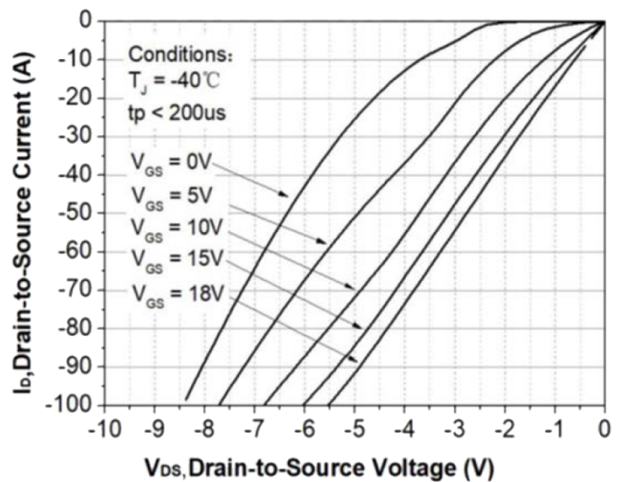

Fig 12: 3rd Quadrant Characteristic ($T_J = -40^\circ\text{C}$)

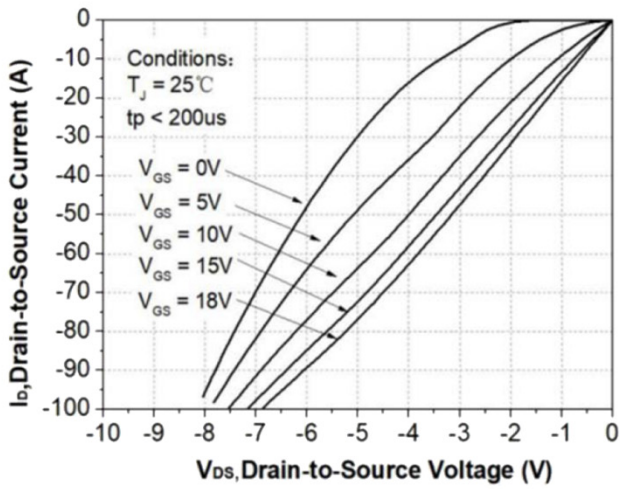

Fig 13: 3rd Quadrant Characteristic($T_J=25^\circ\text{C}$)

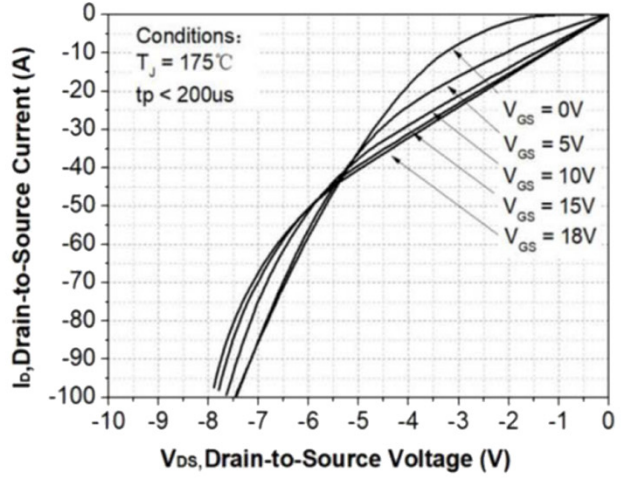

Fig 14: 3rd Quadrant Characteristic($T_J=175^\circ\text{C}$)

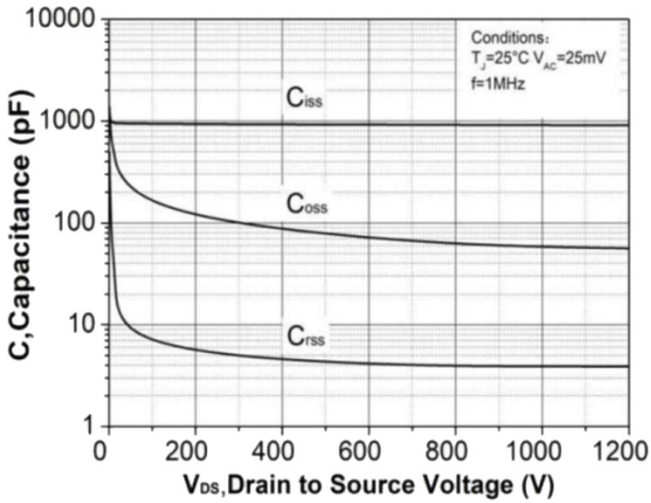

Fig 15: Capacitance Characteristic

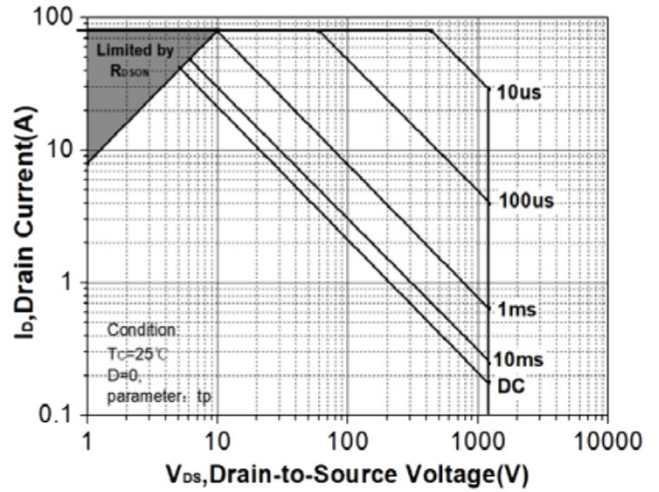

Fig 16: Safe Operating Area

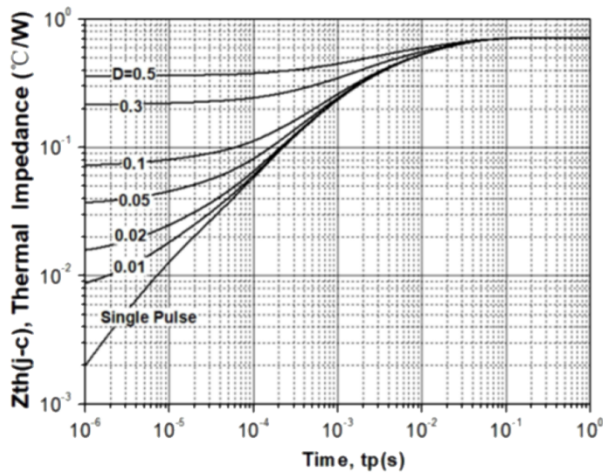
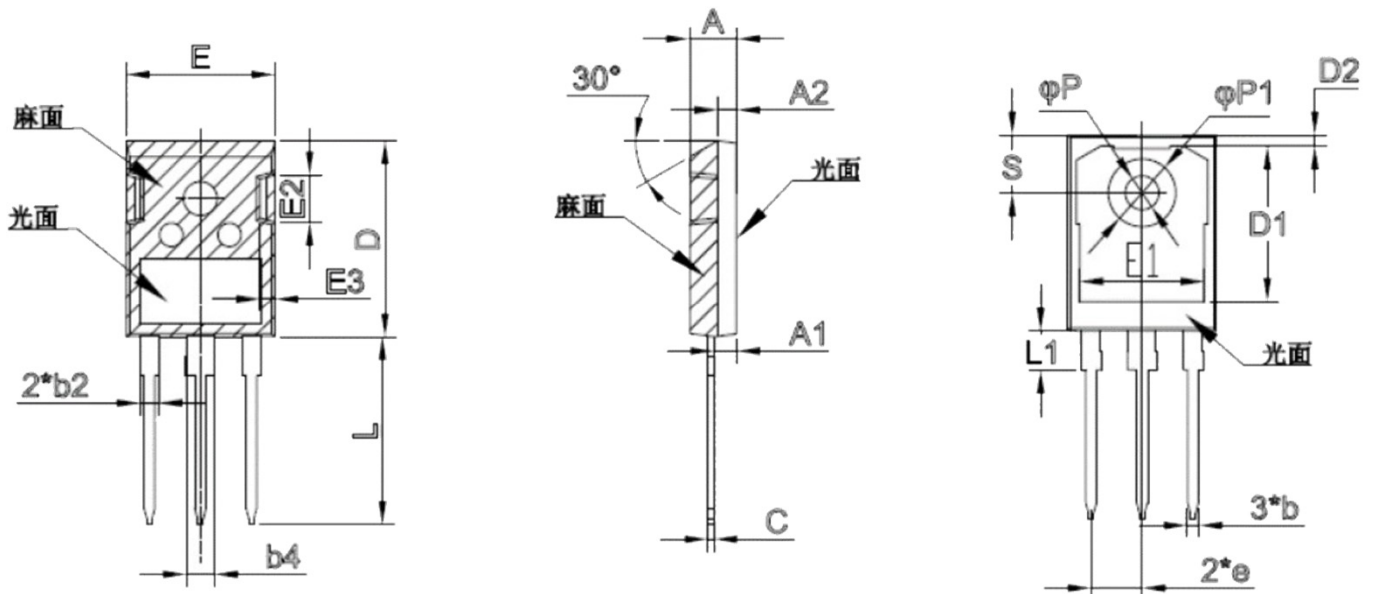



Fig 17: Transient Thermal Impedance

Product dimension (TO-247-3L)



Dim	Millimeters		Inches	
	Min	Max	Min	Max
A	4.70	5.20	0.185	0.205
A1	2.30	2.50	0.091	0.098
A2	1.90	2.10	0.075	0.083
b	1.10	1.30	0.043	0.051
b2	2.00 typ.		0.079 typ.	
b4	3.00 typ.		0.118 typ.	
C	0.50	0.70	0.020	0.028
D	20.80	21.10	0.819	0.831
D1	16.55 typ.		0.652 typ.	
D2	0.95	1.35	0.037	0.053
E	15.48	16.28	0.609	0.641
E1	13.06	13.56	0.514	0.534
E2	4.90	5.10	0.193	0.201
E3	1.50	1.70	0.059	0.067
e	5.34	5.54	0.210	0.218
L	19.80	20.32	0.780	0.800
L1	-	4.50	-	0.177
P	3.50	3.70	0.138	0.146
P1	7.00	7.40	0.276	0.291
S	6.04	6.30	0.238	0.248

IMPORTANT NOTICE

 and **Prisemi**[®] are registered trademarks of **Prisemi Electronics Co., Ltd** (Prisemi), Prisemi reserves the right to make changes without further notice to any products herein. Prisemi makes no warranty, representation or guarantee regarding the suitability of its products for any particular purpose, nor does Prisemi assume any liability arising out of the application or use of any product or circuit, and specifically disclaims any and all liability, including without limitation special, consequential or incidental damages. "Typical" parameters which may be provided in Prisemi data sheets and/or specifications can and do vary in different applications and actual performance may vary over time. All operating parameters, including "Typicals" must be validated for each customer application by customer's technical experts. Prisemi does not convey any license under its patent rights nor the rights of others. The products listed in this document are designed to be used with ordinary electronic equipment or devices, Should you intend to use these products with equipment or devices which require an extremely high level of reliability and the malfunction of with would directly endanger human life (such as medical instruments, aerospace machinery, nuclear-reactor controllers, fuel controllers and other safety devices), please be sure to consult with our sales representative in advance.

Website: <http://www.prisemi.com>

For additional information, please contact your local Sales Representative.

©Copyright 2009, Prisemi Electronics

 **Prisemi**[®] is a registered trademark of Prisemi Electronics.

All rights are reserved.