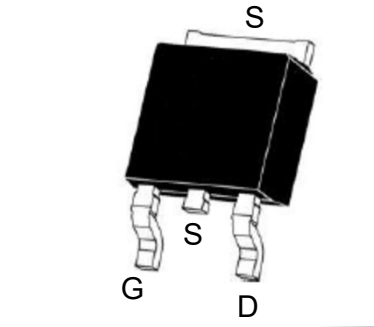
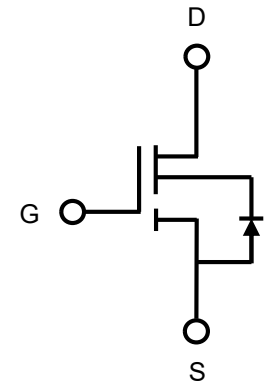
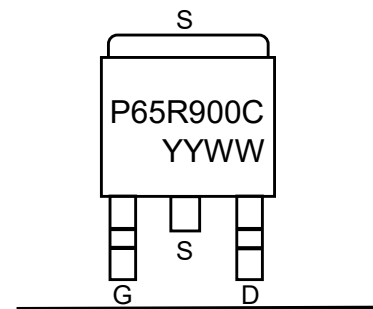

650V Enhancement-mode GaN Transistor

Description

650V Normally-OFF GaN			
$V_{DS}(V)$	$R_{DS(on)}(m\Omega)$	$I_{DS}(A)$	$Q_G(nC)$
650	900	3.6	7.9

TO-252 (Top View)

Circuit Diagram

Marking (Top View)

Feature

- Easy to drive compatible with standard gate
- Low conduction and switching losses
- RoHS compliant and Halogen
- Package: TO-252

Applications

- Adapter
- Renewable energy
- Telecom and data-com
- Servo motors
- Industrial
- Automotive

Absolute maximum rating@25°C

Rating		Symbol	Value	Units
Drain-Source Voltage		V_{DS}	650	V
Drain-Source Voltage-transient ¹⁾		$V_{DS(transient)}$	800	V
Gate-Source Voltage		V_{GS}	-20 to +20	V
Drain Current-Continuous ²⁾	$T_C = 25^\circ C$	I_D	3.6	A
	$T_C = 125^\circ C$		1.6	A
Pulse Drain Current (pulse width: 100μs)		I_{DM}	5	A
Maximum Power Dissipation		P_D	21	W
Junction and Storage Temperature Range		T_J, T_{STG}	-55~+150	°C

Notes:

1. In off-state, spike duty cycle $D < 0.01$, spike duration $< 1\mu s$
2. For increased stability at high current operation.

Thermal characteristics

Parameter	Symbol	Min.	Typ.	Max.	Units
Thermal Resistance, Junction - Case	$R_{\theta JC}$	-	6.0	-	$^{\circ}\text{C}/\text{W}$

Electrical characteristics per line@25°C (unless otherwise specified)

Parameter	Symbol	Conditions	Min.	Typ.	Max.	Units
Drain-Source Breakdown Voltage	BV_{DSS}	$V_{GS}=0\text{V}$	650	-	-	V
Total Drain Leakage Current	I_{DSS}	$V_{DS}=650\text{V}, V_{GS}=0\text{V}, T_J=25^{\circ}\text{C}$	-	-	10	μA
		$V_{DS}=650\text{V}, V_{GS}=0\text{V}, T_J=150^{\circ}\text{C}$	-	-	100	
Gate Threshold Voltage	$V_{GS(th)}$	$V_{GS}=V_{DS}, I_{DS}=1\text{mA}$	3.3	4.0	4.8	V
Gate Threshold Voltage Temperature Coefficient	$\Delta V_{GS(th)}/T_J$		-	-7	-	$\text{mV}/^{\circ}\text{C}$
Gate-Source Leakage Current	I_{GSS}	$V_{GS}=\pm 20\text{V}$	-	-	± 100	nA
Static Drain-Source On-Resistance	$R_{DS(on)}$	$V_{GS}=10\text{V}, I_D=1\text{A}, T_J=25^{\circ}\text{C}$	-	900	1080	$\text{m}\Omega$
		$V_{GS}=10\text{V}, I_D=1\text{A}, T_J=150^{\circ}\text{C}$	-	1900	-	
Input Capacitance	C_{iss}	$V_{DS}=400\text{V}, V_{GS}=0\text{V}, f=1\text{MHz}$	-	293	-	pF
Output Capacitance	C_{oss}		-	17	-	
Reverse Transfer Capacitance	C_{rss}		-	3.74	-	
Output Charge	Q_{oss}	$V_{GS}=0\text{V}, V_{DS}=0\text{V to }400\text{V}, f=1\text{MHz}$	-	22.2	-	nC
Total Gate Charge	Q_g	$V_{GS}=0\text{ to }10\text{V}, V_{DS}=400\text{V}, I_D=1\text{A}$	-	7.9	-	nC
Gate-Source Charge	Q_{gs}		-	2.31	-	
Gate-Drain Charge	Q_{gd}		-	1.65	-	
Turn-on Delay Time	$t_{d(on)}$	$V_{DS}=400\text{V}, V_{GS}=0\text{V to }10\text{V}, I_D=2.1\text{A}, R_{G-on(ext)}=6.8\Omega, R_{G-off(ext)}=2.2\Omega, L=250\mu\text{H}$	-	3.2	-	ns
Turn-on Rise Time	t_r		-	5.5	-	
Turn-Off Delay Time	$t_{d(off)}$		-	7.4	-	
Turn-Off Fall Time	t_f		-	27	-	
Reverse Device Characteristics						
Diode Forward Voltage	V_{SD}	$V_{GS}=0\text{V}, I_{SD}=2.5\text{A}$	-	2.2	-	V
Reverse Recovery Time	t_{rr}	$I_F=2.5\text{A}, V_{DD}=400\text{V}, di_F/dt=165\text{A}/\mu\text{s}$	-	14	-	ns
Reverse Recovery Charge	Q_{rr}		-	6.5	-	nC

Typical Characteristics

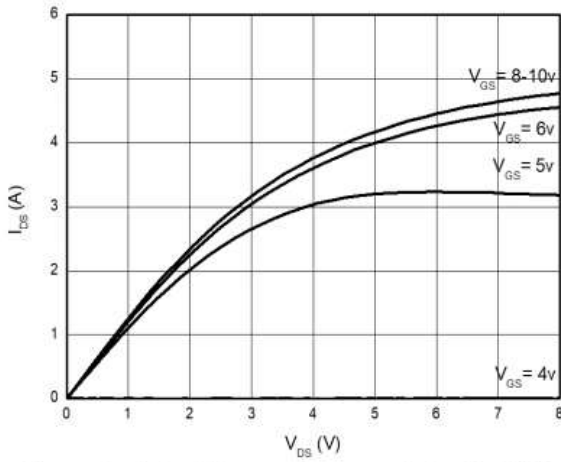

Figure 1. Typical Output Characteristics $T_j=25^\circ\text{C}$

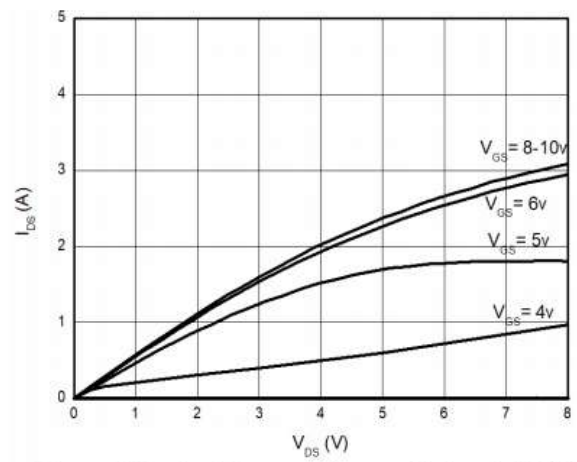

Figure 2. Typical Output Characteristics $T_j=125^\circ\text{C}$

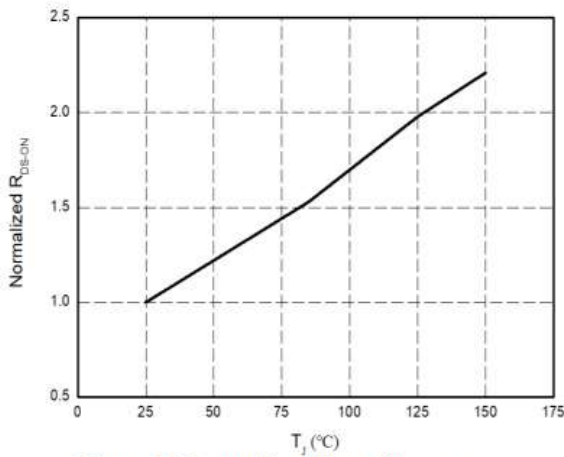

Figure 3. Normalized On-resistance

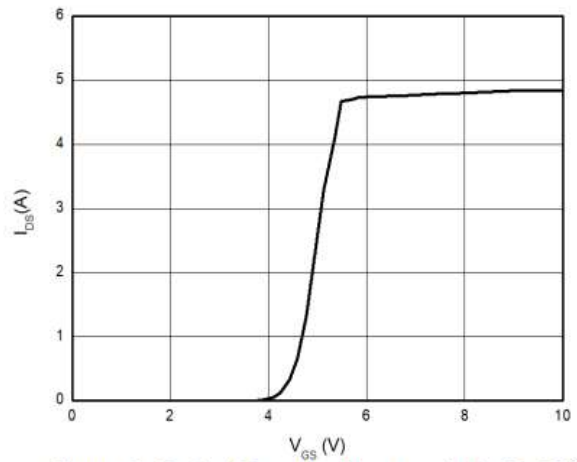

Figure 4. Typical Transfer Characteristics $T_j=25^\circ\text{C}$

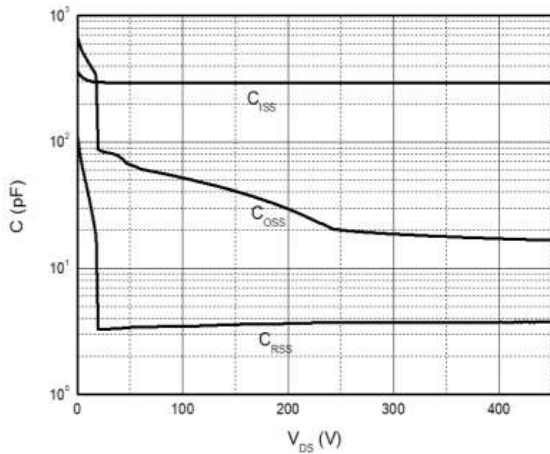

Figure 5. Typical Capacitance ($f=1\text{MHz}$)

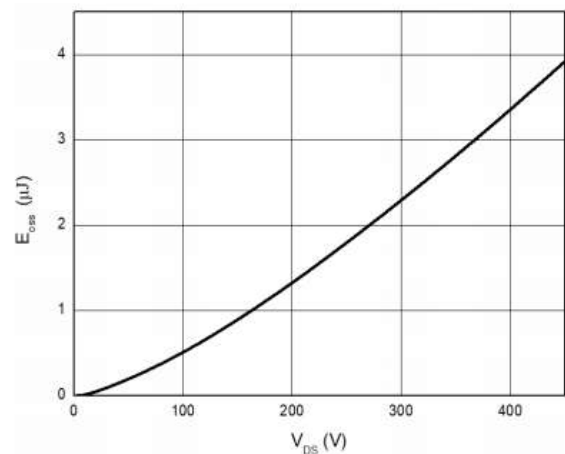

Figure 6. Typical C_{oss} Stored Energy

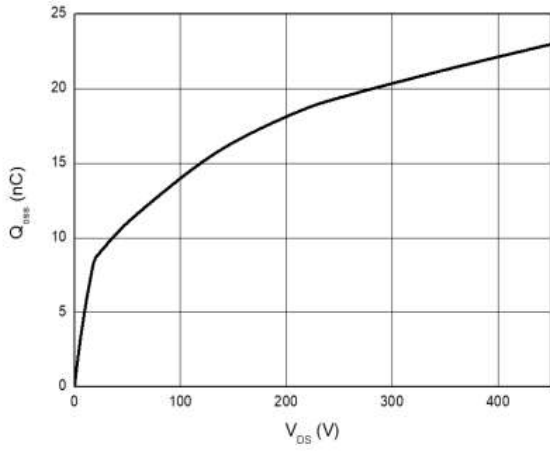

Figure 7. Typical Q_{oss}

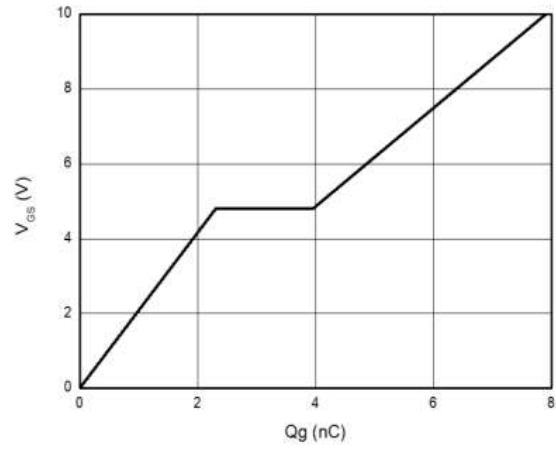

Figure 8. Typical Gate Charge ($V_{DS}=400V, I_D=1A$)

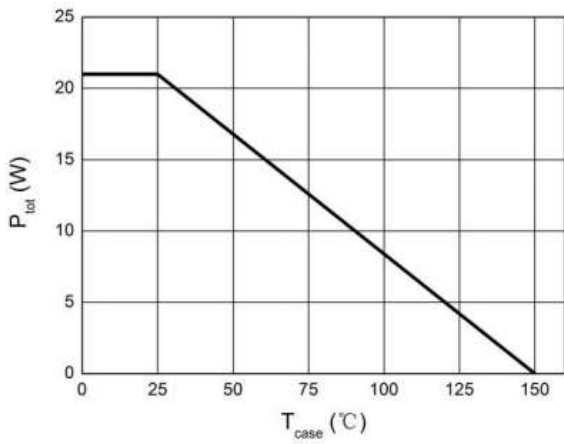
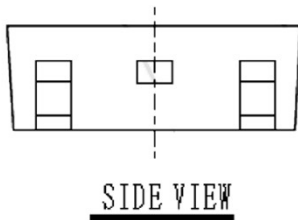
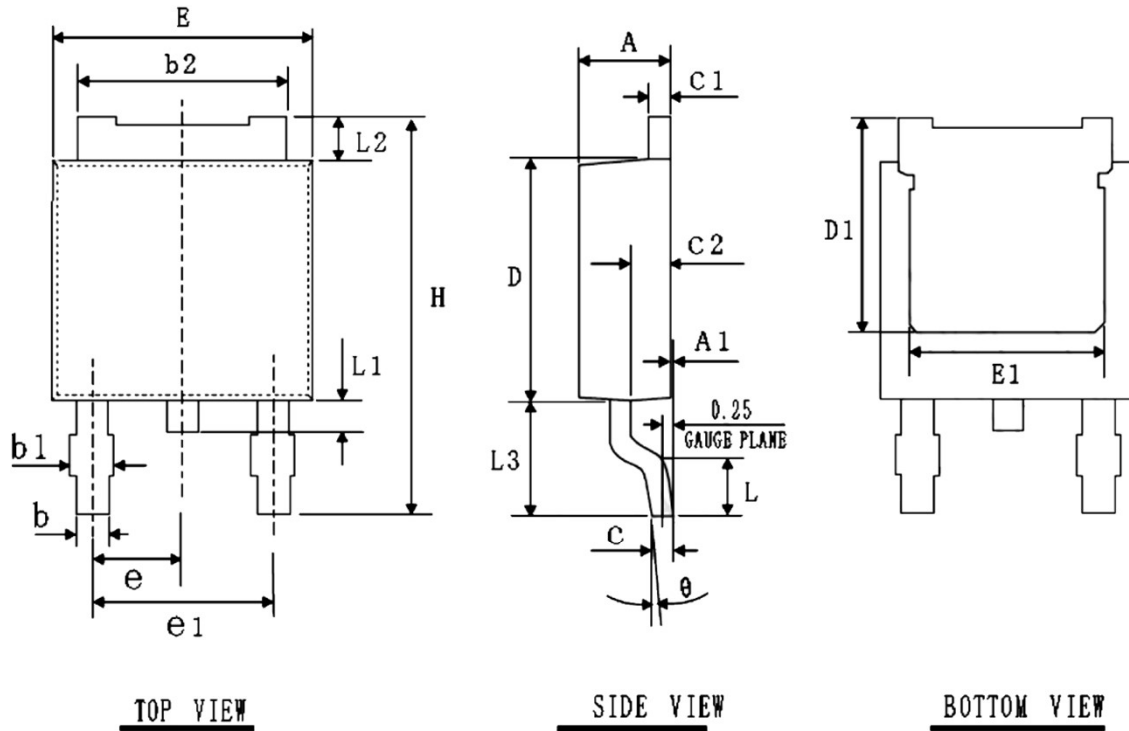



Figure 9. Power Dissipation

Product Dimension (TO-252)



SYMB OL	Millimeters			SYMB OL	Millimeters			SYMB OL	Millimeters		
	MIN	NOM	MAX		MIN	NOM	MAX		MIN	NOM	MAX
A	2.20	2.30	2.40	D1	5.25	5.45	5.65	θ	0°	4°	8°
A1	0.00	0.05	0.10	H	10.00	10.10	10.20	e 2.285 BSC			
b	0.762	0.812	0.862	E	6.50	6.60	6.70				
b 1	--	--	1.10	E1	4.75	4.85	4.95				
b2	5.23	5.33	5.43	e1	4.37	4.57	4.77				
C	0.458	0.508	0.558	L	--	--	1.45				
C1	0.458	0.508	0.558	L1	0.60	0.75	0.90				
C2	0.80	1.00	1.20	L2	0.90	1.10	1.30				
D	6.00	6.10	6.20	L3	2.80	3.00	3.20				

IMPORTANT NOTICE

 and **Prisemi**[®] are registered trademarks of **Prisemi Electronics Co., Ltd** (Prisemi), Prisemi reserves the right to make changes without further notice to any products herein. Prisemi makes no warranty, representation or guarantee regarding the suitability of its products for any particular purpose, nor does Prisemi assume any liability arising out of the application or use of any product or circuit, and specifically disclaims any and all liability, including without limitation special, consequential or incidental damages. “Typical” parameters which may be provided in Prisemi data sheets and/or specifications can and do vary in different applications and actual performance may vary over time. All operating parameters, including “Typicals” must be validated for each customer application by customer’s technical experts. Prisemi does not convey any license under its patent rights nor the rights of others. The products listed in this document are designed to be used with ordinary electronic equipment or devices, Should you intend to use these products with equipment or devices which require an extremely high level of reliability and the malfunction of which would directly endanger human life (such as medical instruments, aerospace machinery, nuclear-reactor controllers, fuel controllers and other safety devices), please be sure to consult with our sales representative in advance.

Website: <http://www.prisemi.com>

For additional information, please contact your local Sales Representative.

©Copyright 2009, Prisemi Electronics

 **Prisemi**[®] is a registered trademark of Prisemi Electronics.

All rights are reserved.