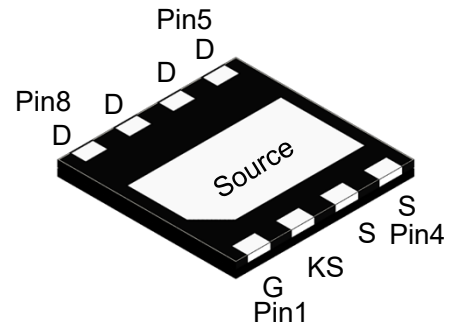
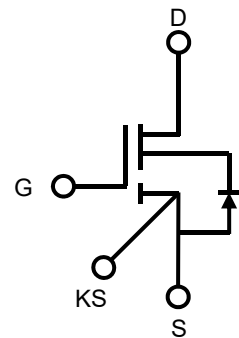
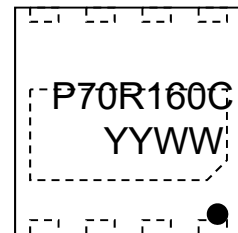

700V Enhancement-mode GaN Transistor

Description

700V Normally-OFF GaN			
$V_{DS}(V)$	$R_{DS(on)}(m\Omega)$	$I_{DS}(A)$	$Q_G(nC)$
700	160	16	7.8

Bottom View

Circuit Diagram

Marking (Top View)

Feature

- Normally-off device combines high voltage GaN HEMT and low voltage silicon MOSFET
- Normally off power switch
- Low reverse-recovery charge
- High switching frequency
- Low gate charge, low output charge
- Qualified for industrial applications according to JEDEC Standards
- Package:DFN8*8-8L

Applications

- Fast charger
- Renewable energy
- Telecom and data-com
- Servo motors
- Industrial
- Automotive

Absolute maximum rating@25°C

Rating	Symbol	Value	Units	
Drain-Source Voltage	V_{DS}	700	V	
Drain-Source Voltage-transient ¹⁾	$V_{DS(transient)}$	800	V	
Gate-Source Voltage	V_{GS}	-20 to +20	V	
Drain Current-Continuous ²⁾	I_D	$T_C = 25^\circ C$	16	A
		$T_C = 125^\circ C$	7.0	A
Pulse Drain Current (pulse width: 100 μ s)	I_{DM}	21	A	
Maximum Power Dissipation	P_D	78	W	
Junction and Storage Temperature Range	T_J, T_{STG}	-55~+150	$^\circ C$	

Notes:

1. In off-state, spike duty cycle $D < 0.01$, spike duration $< 1\mu s$
2. For increased stability at high current operation.

Thermal characteristics

Parameter	Symbol	Min.	Typ.	Max.	Units
Thermal Resistance, Junction - Case	$R_{\theta JC}$	-	1.6	-	$^{\circ}\text{C}/\text{W}$

Electrical characteristics per line@25°C (unless otherwise specified)

Parameter	Symbol	Conditions	Min.	Typ.	Max.	Units
Drain-Source Breakdown Voltage	BV_{DSS}	$V_{GS} = 0\text{V}$	700	-	-	V
Total Drain Leakage Current	I_{DSS}	$V_{DS} = 700\text{V}, V_{GS} = 0\text{V}$	-	-	10	μA
		$V_{DS} = 700\text{V}, V_{GS} = 0\text{V}, T_J = 150^{\circ}\text{C}$	-	-	100	
Gate Threshold Voltage	$V_{GS(th)}$	$V_{GS} = V_{DS}, I_D = 1\text{mA}$	1.0	1.7	3.0	V
Gate Threshold Voltage Temperature Coefficient	$\Delta V_{GS(th)}/T_J$		-	-6.8	-	$\text{mV}/^{\circ}\text{C}$
Gate-Source Leakage Current	I_{GSS}	$V_{GS} = \pm 20\text{V}$	-	-	± 100	nA
Static Drain-Source On-Resistance	$R_{DS(on)}$	$V_{GS} = 10\text{V}, I_D = 1\text{A}$	-	160	220	$\text{m}\Omega$
		$V_{GS} = 10\text{V}, I_D = 1\text{A}, T_J = 150^{\circ}\text{C}$	-	340	-	
Input Capacitance	C_{iss}	$V_{DS} = 400\text{V}, V_{GS} = 0\text{V}, f = 1\text{MHz}$	-	378	-	pF
Output Capacitance	C_{oss}		-	23	-	
Reverse Transfer Capacitance	C_{rss}		-	0.97	-	
Output Charge	Q_{oss}	$V_{GS} = 0\text{V}, V_{DS} = 0\text{V to } 400\text{V}, f = 1\text{MHz}$	-	36	-	nC
Total Gate Charge	Q_g	$V_{GS} = 0 \text{ to } 10\text{V}, V_{DS} = 400\text{V}, I_D = 1\text{A}$	-	7.8	-	nC
Gate-Source Charge	Q_{gs}		-	1.1	-	
Gate-Drain Charge	Q_{gd}		-	1.8	-	
Turn-on Delay Time	$t_{d(on)}$	$V_{DS} = 400\text{V}, V_{GS} = 0\text{V to } 10\text{V}, I_D = 2.1\text{A}, R_{G-on(ext)} = 6.8\Omega, R_{G-off(ext)} = 2.2\Omega, L = 250\mu\text{H}$	-	2.5	-	ns
Turn-on Rise Time	t_r		-	7.0	-	
Turn-Off Delay Time	$t_{d(off)}$		-	9.7	-	
Turn-Off Fall Time	t_f		-	28	-	
Reverse Device Characteristics						
Diode Forward Voltage	V_{SD}	$V_{GS} = 0\text{V}, I_{SD} = 10\text{A}$	-	2.5	-	V
Reverse Recovery Time	t_{rr}	$I_F = 10\text{A}, V_{DD} = 400\text{V}, di_F/dt = 165\text{A}/\mu\text{s}$	-	13	-	ns
Reverse Recovery Charge	Q_{rr}		-	3.2	-	nC

Typical Characteristics

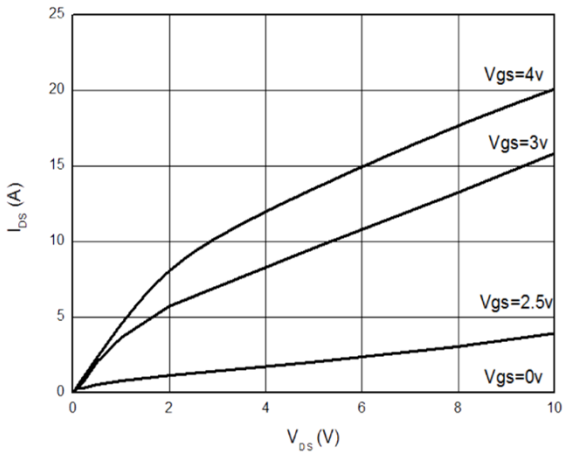

Figure 1. Typical Output Characteristics $T_j=25^\circ\text{C}$

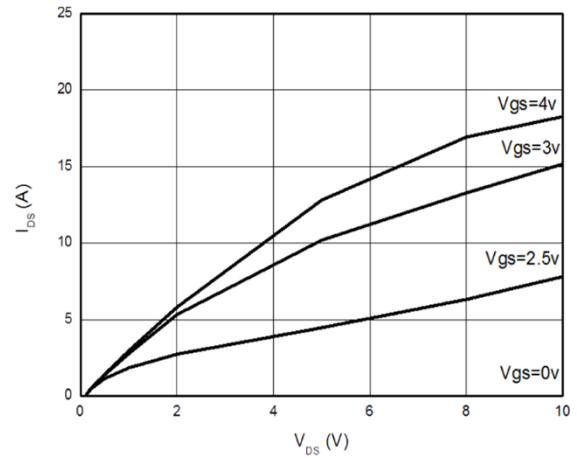

Figure 2. Typical Output Characteristics $T_j=125^\circ\text{C}$

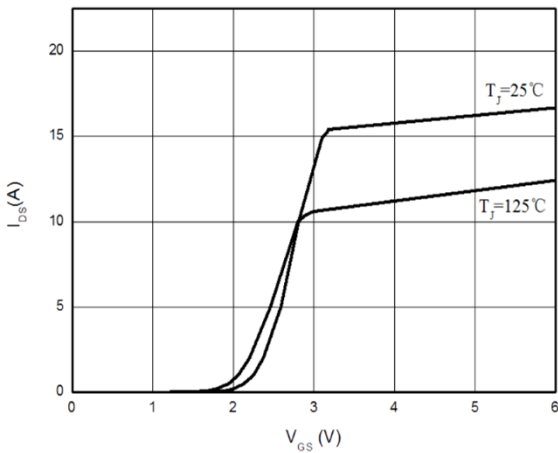

Figure 3. Typical Transfer Characteristics ($V_{DS}=5\text{V}$)

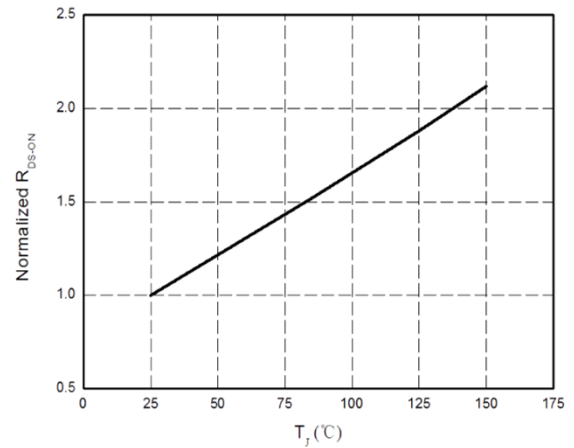

Figure 4. Normalized On-resistance

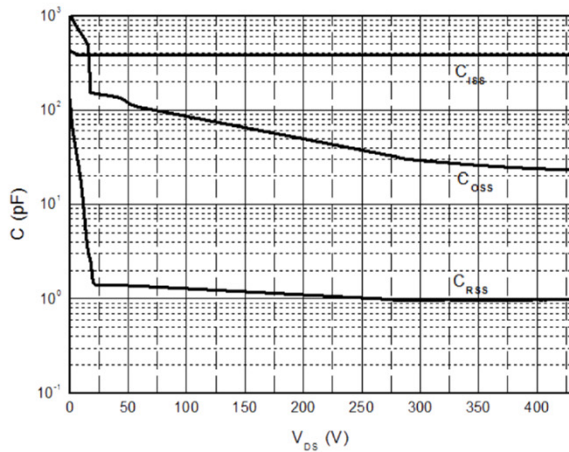

Figure 5. Typical Capacitance ($f=1\text{MHz}$)

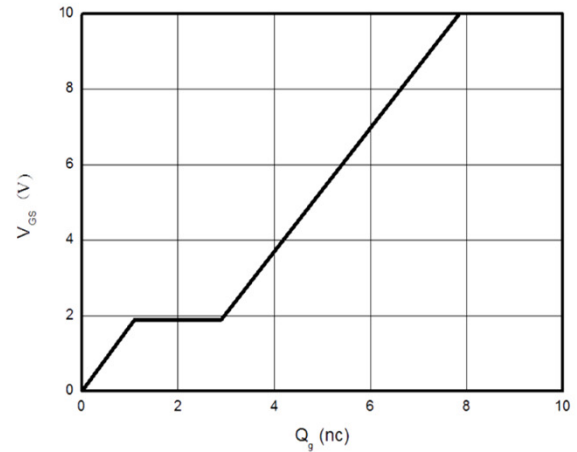

Figure 6. Typical Gate Charge ($V_{DS}=400\text{V}$, $I_D=1\text{A}$)

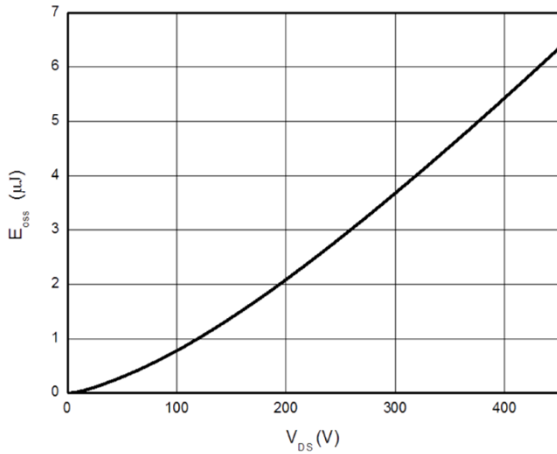

Figure 7. Typical Coss Stored Energy

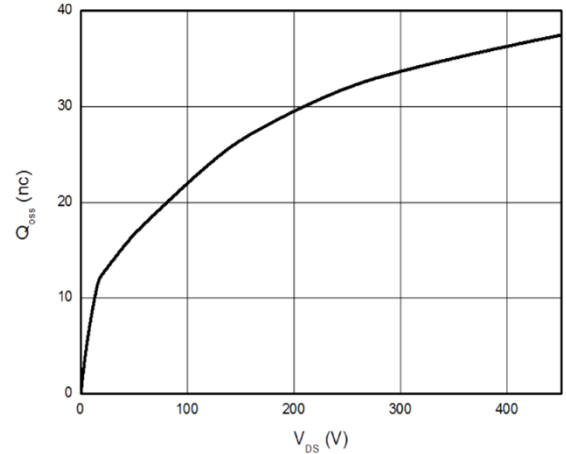

Figure 8. Typical Qoss

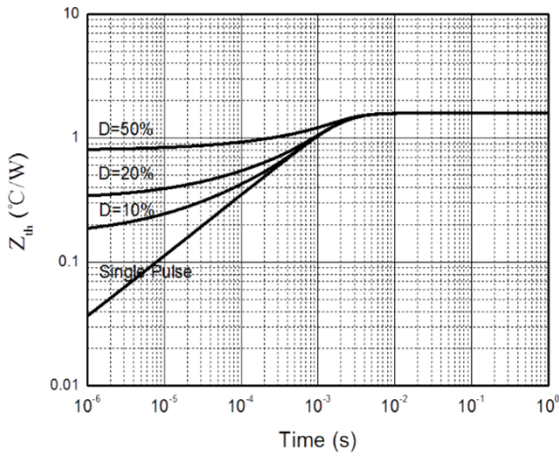

Figure 9. Transient Thermal Resistance

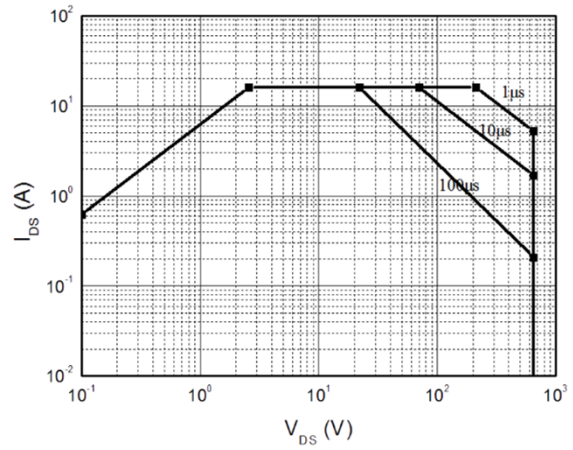

Figure 10. Safe Operating Area Tj=25°C

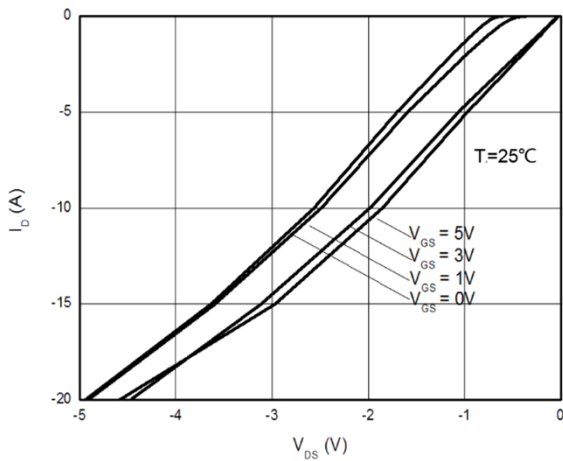

Figure 11. Channel Reverse Characteristics Tj=25°C

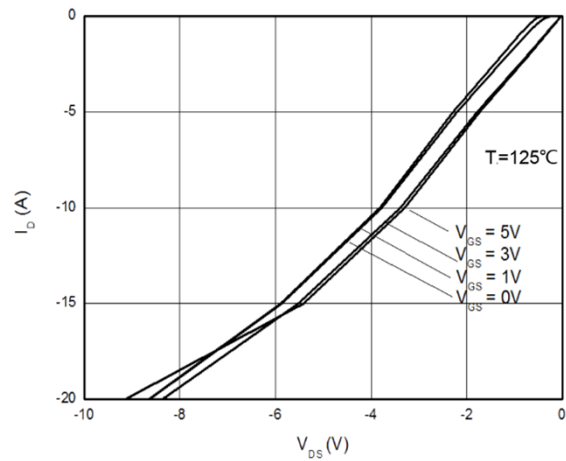
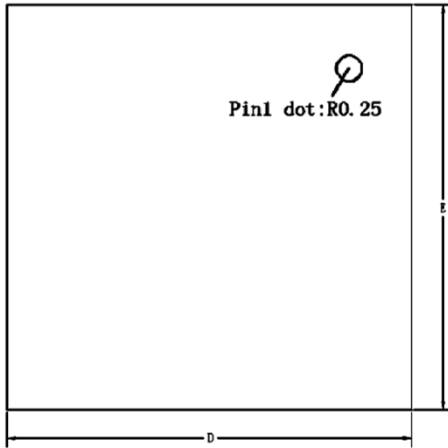

Figure 12 Channel Reverse Characteristics Tj=125°C

Product Dimension (DFN8*8-8L)

Top view



Bottom view

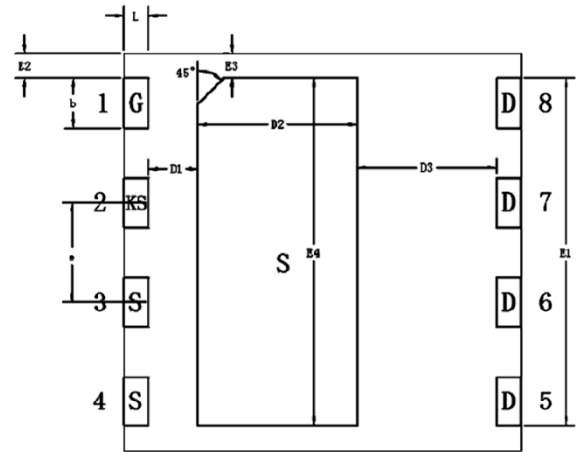

Side view(left/right)

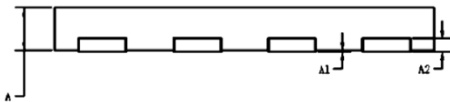

Dim	Millimeters		Inches		Dim	Millimeters		Inches	
	Min	Max	Min	Max		Min	Max	Min	Max
A	1.05	1.15	0.041	0.045	E1	6.90	7.10	0.272	0.280
A1	0.00	0.05	0.000	0.002	E2	0.40	0.60	0.016	0.024
A2	0.203 Ref.		0.008 Ref.		E3	0.40	0.60	0.016	0.024
D	7.90	8.10	0.311	0.319	E4	6.90	7.10	0.272	0.280
E	7.90	8.10	0.311	0.319	b	0.90	1.10	0.035	0.043
D1	0.90	1.10	0.035	0.043	e	1.90	2.10	0.075	0.083
D2	3.10	3.30	0.122	0.130	L	0.40	0.60	0.016	0.024
D3	2.70	2.90	0.106	0.114					

IMPORTANT NOTICE

 and **Prisemi**[®] are registered trademarks of **Prisemi Electronics Co., Ltd** (Prisemi), Prisemi reserves the right to make changes without further notice to any products herein. Prisemi makes no warranty, representation or guarantee regarding the suitability of its products for any particular purpose, nor does Prisemi assume any liability arising out of the application or use of any product or circuit, and specifically disclaims any and all liability, including without limitation special, consequential or incidental damages. "Typical" parameters which may be provided in Prisemi data sheets and/or specifications can and do vary in different applications and actual performance may vary over time. All operating parameters, including "Typicals" must be validated for each customer application by customer's technical experts. Prisemi does not convey any license under its patent rights nor the rights of others. The products listed in this document are designed to be used with ordinary electronic equipment or devices, Should you intend to use these products with equipment or devices which require an extremely high level of reliability and the malfunction of with would directly endanger human life (such as medical instruments, aerospace machinery, nuclear-reactor controllers, fuel controllers and other safety devices), please be sure to consult with our sales representative in advance.

Website: <http://www.prisemi.com>

For additional information, please contact your local Sales Representative.

©Copyright 2009, Prisemi Electronics

 **Prisemi**[®] is a registered trademark of Prisemi Electronics.

All rights are reserved.