

Description

The MOSFET provide the best combination of fast switching, low on-resistance and cost-effectiveness.

MOSFET Product Summary		
V _{DS} (V)	R _{DS(on)} (mΩ)	I _D (A)
30	3.7@ VGS=4.5V	23

Top View (SOP-8)

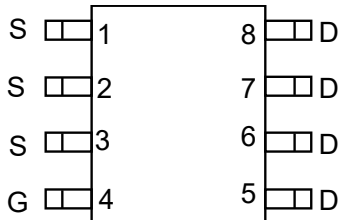

Internal Structure

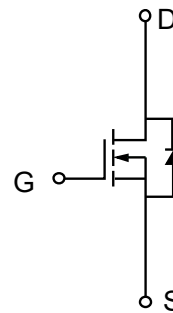

Absolute maximum rating@25°C

Parameter	Symbol	Maximum	Units	
Drain-Source Voltage	V _{DS}	30	V	
Gate-Source Voltage	V _{GS}	±20	V	
Continuous Drain Current (T _J =150°C)	I _D	T _A =25°C 23	A	
		T _A =70°C 18		
Pulsed Drain Current	I _{DM}	80	A	
Maximum Power Dissipation	P _D	T _A =25°C 2.72	W	
		T _A =70°C 1.74		
Operating Junction and Storage Temperature Range	T _J	-55 to 150	°C	
Thermal Characteristics				
Parameter	Symbol	Typical	Maximum	Units
Thermal Resistance-Junction to Ambient	R _{θJA}	46	62.5	°C/W

Electrical characteristics per line@25°C (unless otherwise specified)

Parameter	Symbol	Conditions	Min.	Typ.	Max.	Units
Drain-Source Breakdown Voltage	BV_{DSS}	$I_D = 250\mu A, V_{GS} = 0V$	30		-	V
Zero Gate Voltage Drain Current	I_{BSS}	$V_{DS} = 20V, V_{GS} = 0V$	-	-	1	μA
Gate-Body Leakage Current	I_{GSS}	$V_{DS} = 0V, V_{GS} = \pm 20V$	-	-	± 100	nA
Gate Threshold Voltage	$V_{GS(th)}$	$V_{DS} = V_{GS}, I_D = 250\mu A$	1		3	V
Static Drain-Source On-Resistance	$R_{DS(on)}$	$V_{GS} = 10V, I_D = 15A$	-	2.5	3.2	m Ω
		$V_{GS} = 4.5V, I_D = 10A$	-	3.7	4.9	
Drain-Source Diode Forward Voltage	V_{SD}	$V_{GS} = 0V, I_S = 15A$		0.8		V
Total Gate Charge	Qg	$V_{GS} = 4.5V, V_{DS} = 15V, I_D = 10A$		43		nC
Total Gate Charge	Qg	$V_{GS} = 10V, V_{DS} = 15V, I_D = 10A$		84		
Gate-Source Charge	Qgs			14		
Gate-Drain Charge	Qgd			21		
Input Capacitance	C_{ISS}	$V_{GS} = 0V, V_{DS} = 15V, f = 1MHz$	-	3880		pF
Output Capacitance	C_{OSS}		-	690		pF
Reverse Transfer Capacitance	C_{RSS}		-	225		pF
Turn-On Delay Time	$t_{d(on)}$	$V_{DD} = 15V, V_{GEN} = 10V, R_G = 1\Omega, R_L = 15\Omega, I_D = 1A$	-	27		ns
Turn-Off Delay Time	$t_{d(off)}$		-	85		ns
Turn-On Rise Time	t_r		-	20		ns
Turn-On Fall Time	t_f		-	18		ns
Gate-Resistance	Rg	$V_{GS} = 0V, V_{DS} = 0V, f = 1MHz$		1.5		Ω

Typical Characteristics

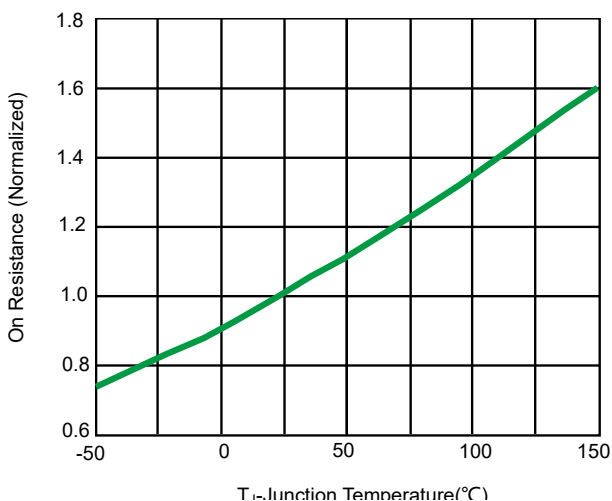

Fig 1. On Resistance vs. Junction Temperature

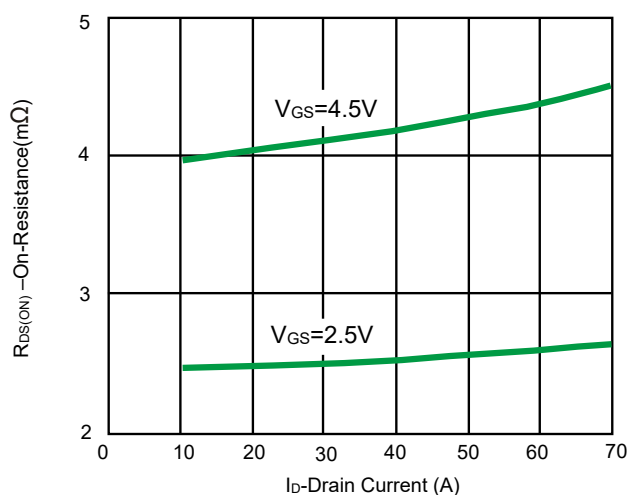

Fig 2. On-Resistance vs. Drain Current

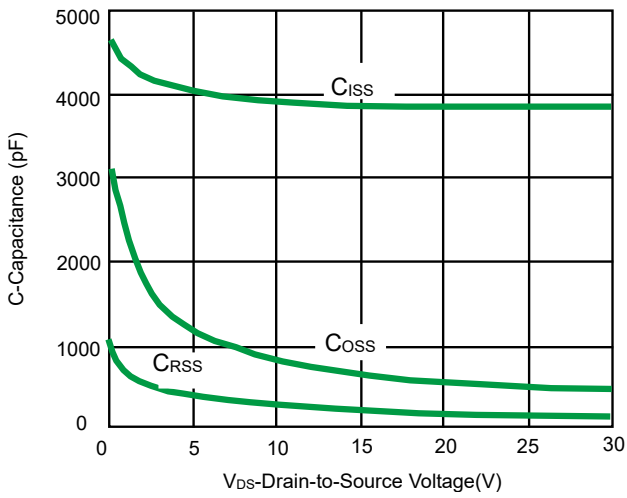

Fig 3. Capacitance

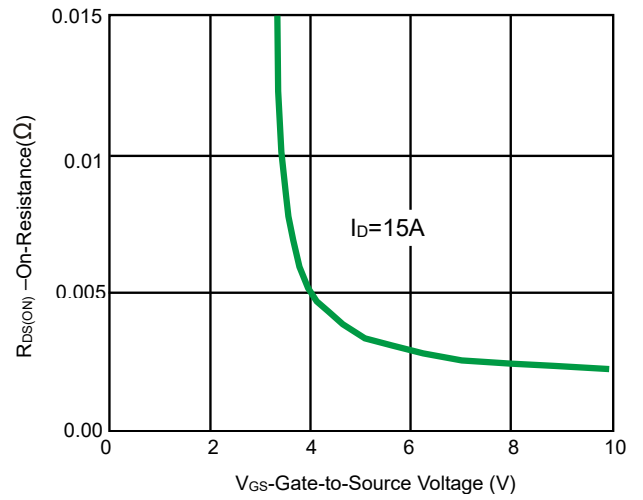

Fig 4. On-Resistance vs. Gate-to-Source Voltage

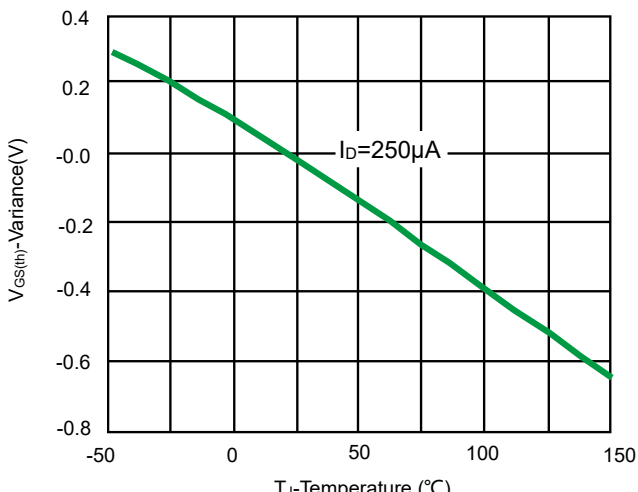

Fig 5. Threshold Voltage

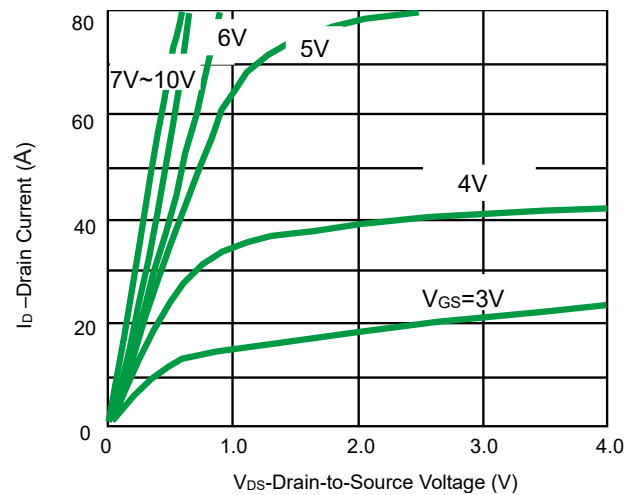

Fig 6. On-Region Characteristics

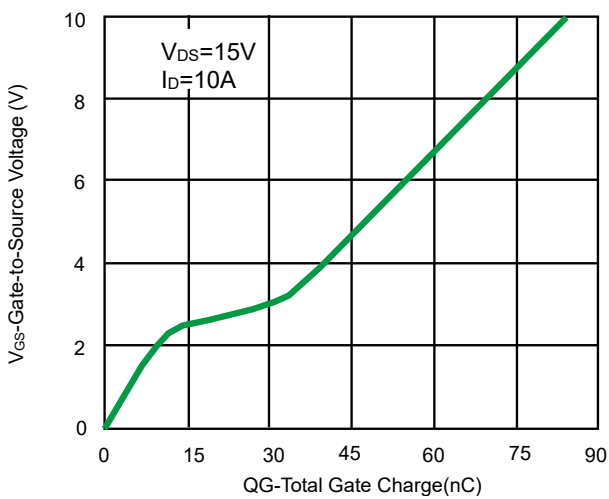

Fig 7. Gate Charge

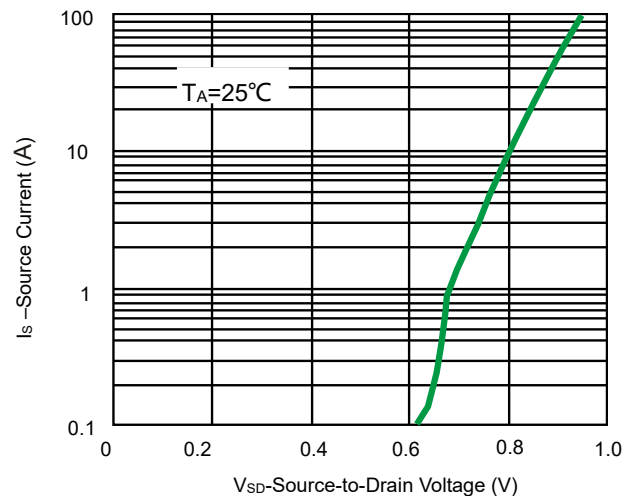

Fig 8. Source to Drain Diode Forward Voltage

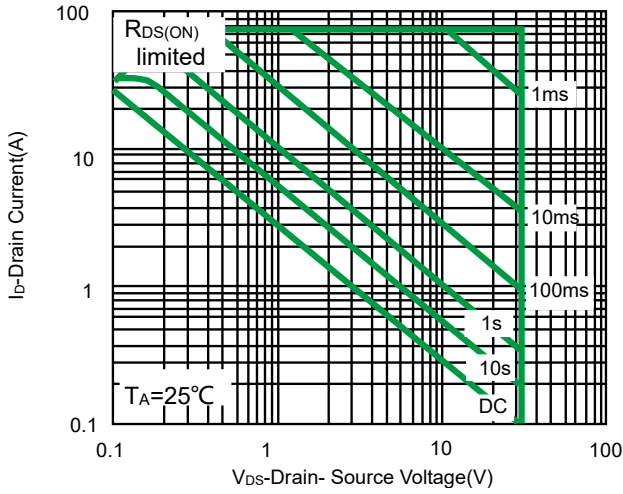

Fig 9. Maximum Forward Biased Safe Operating Area

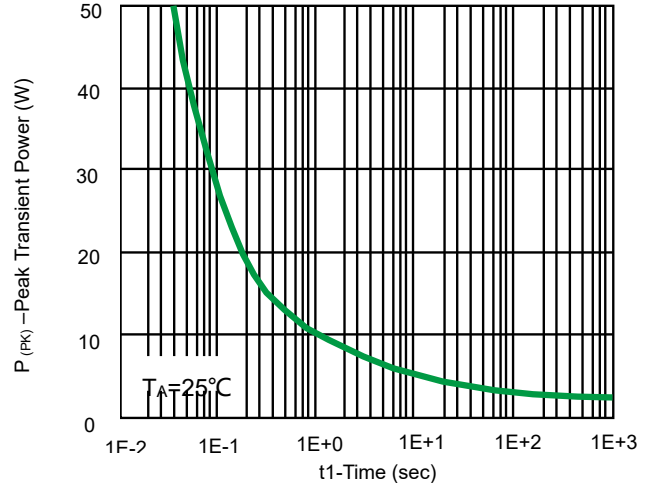

Fig 10. Single Pulse Maximum Power Dissipation

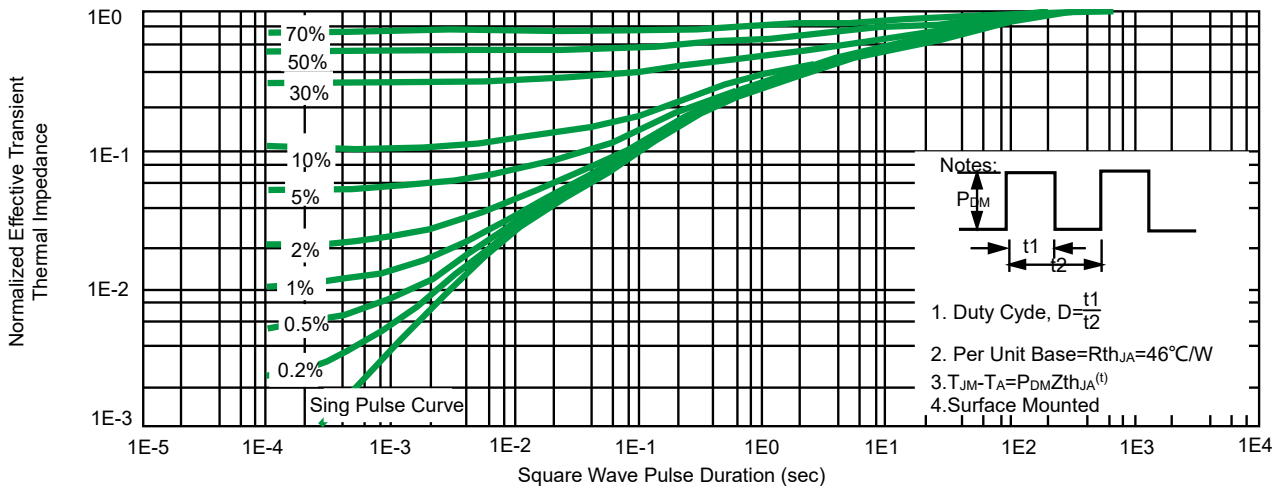
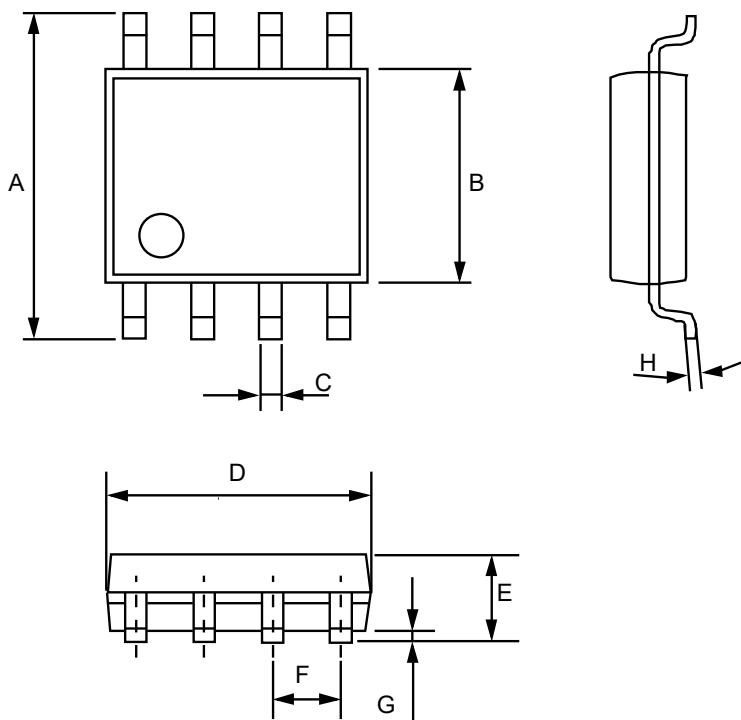

Fig 11. Normalized Thermal Transient Impedance, Junction-to-Ambient

Product dimension (SOP-8)



Dim	Millimeters		Inches	
	MIN	MAX	MIN	MAX
A	5.800	6.200	0.228	0.244
B	3.800	4.000	0.150	0.157
C	0.330	0.510	0.013	0.020
D	4.700	5.100	0.185	0.200
E	1.350	1.750	0.053	0.069
F	1.270 (BSC)		0.050 (BSC)	
G	0.100	0.250	0.004	0.010
H	0.170	0.250	0.006	0.010

Ordering information

Device	Package	Reel	Shipping
PNM8P30V20	SOP-8	13"	4000 / Tape & Reel

Load with information

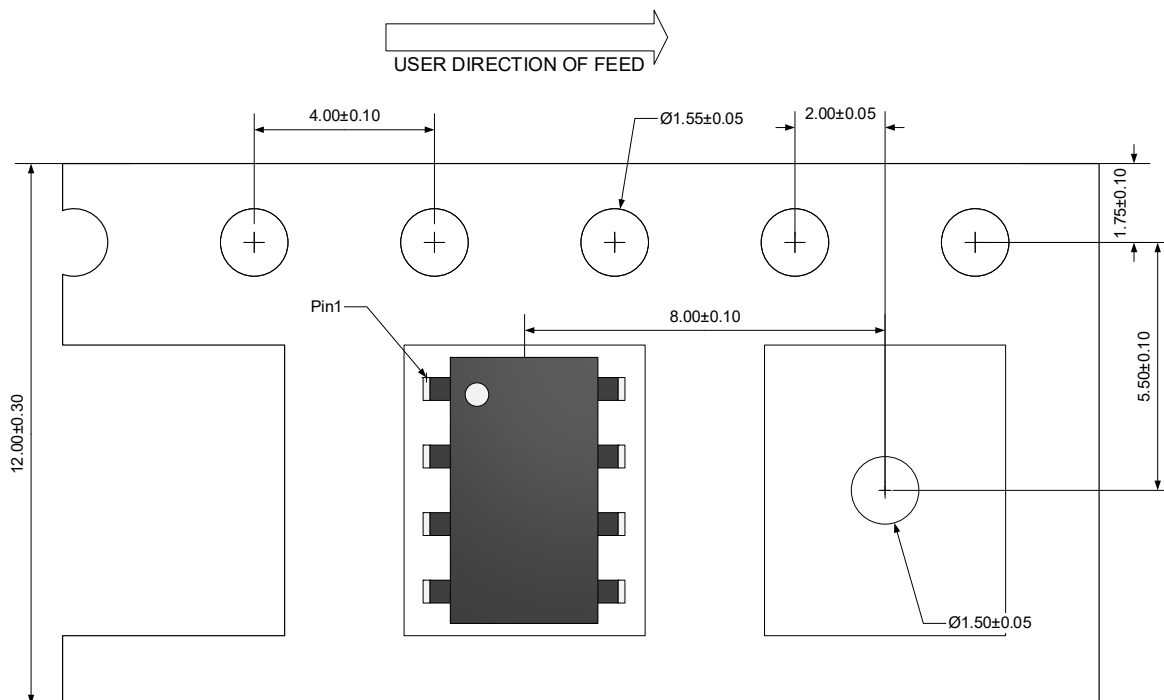

Unit:mm

IMPORTANT NOTICE

 and **Prisemi**[®] are registered trademarks of **Prisemi Electronics Co., Ltd (Prisemi)** ,Prisemi reserves the right to make changes without further notice to any products herein. Prisemi makes no warranty, representation or guarantee regarding the suitability of its products for any particular purpose, nor does Prisemi assume any liability arising out of the application or use of any product or circuit, and specifically disclaims any and all liability, including without limitation special, consequential or incidental damages. “Typical” parameters which may be provided in Prisemi data sheets and/or specifications can and do vary in different applications and actual performance may vary over time. All operating parameters, including “Typicals” must be validated for each customer application by customer’s technical experts. Prisemi does not convey any license under its patent rights nor the rights of others. The products listed in this document are designed to be used with ordinary electronic equipment or devices, Should you intend to use these products with equipment or devices which require an extremely high level of reliability and the malfunction of with would directly endanger human life (such as medical instruments, aerospace machinery, nuclear-reactor controllers, fuel controllers and other safety devices), please be sure to consult with our sales representative in advance.

Website: <http://www.prisemi.com>

For additional information, please contact your local Sales Representative.

©Copyright 2009, Prisemi Electronics

 **Prisemi**[®] is a registered trademark of Prisemi Electronics.

All rights are reserved.