

**Description**

The MOSFET provide the best combination of fast switching, low on-resistance and cost-effectiveness.

MOSFET Product Summary		
V <sub>DS</sub> (V)	R <sub>DS(on)</sub> (mΩ)	I <sub>D</sub> (A)
20	14@ VGS=4.5V	7

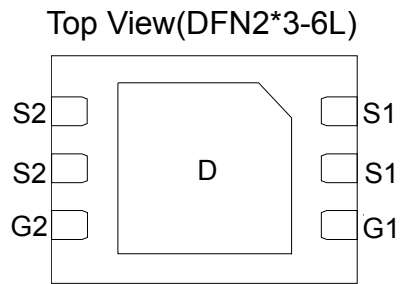
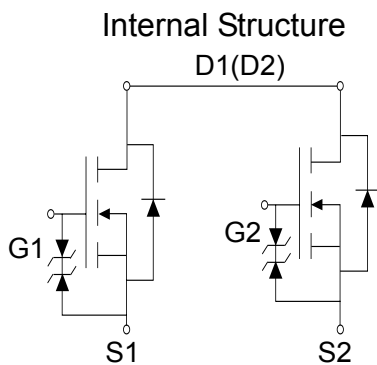

**Absolute maximum rating@25°C**

Parameter	Symbol	Maximum	Units
Drain-Source Voltage	V <sub>DS</sub>	20	V
Gate-Source Voltage	V <sub>GS</sub>	±10	V
Drain Current-Continuous	I <sub>D</sub>	7	A
Drain Current-Pulsed (Note 1)	I <sub>DM</sub>	30	A
Maximum Power Dissipation	P <sub>D</sub>	0.98	W
Operating Junction and Storage Temperature Range	T <sub>J</sub> , T <sub>STG</sub>	-55 to 150	°C

**Absolute maximum rating@25°C**

Parameter	Typical	Maximum	Units
Thermal Resistance,Junction-to-Ambient (Note 2)	R <sub>θJA</sub>	126	°C/W

## Electrical characteristics per line @25°C ( unless otherwise specified)

Parameter	Symbol	Conditions	Min.	Typ.	Max.	Units
Drain-Source Breakdown Voltage	$BV_{DSS}$	$I_D = 250\mu A, V_{GS} = 0V$	20		-	V
Zero Gate Voltage Drain Current	$I_{DSS}$	$V_{DS} = 20V, V_{GS} = 0V$	-	-	1	$\mu A$
Gate-Body Leakage Current	$I_{GSS}$	$V_{DS} = 0V, V_{GS} = \pm 10V$	-	-	$\pm 10$	$\mu A$
Gate Threshold Voltage	$V_{GS(th)}$	$V_{DS} = V_{GS}, I_D = 250\mu A$	0.45	0.7	0.95	V
Drain-Source On-State Resistance	$R_{DS(on)}$	$V_{GS} = 4.5V, I_D = 6.5A$		14	20	m $\Omega$
		$V_{GS} = 2.5V, I_D = 5.5A$		19	25	
Forward Transconductance	$G_{FS}$	$V_{dS} = 5V, I_D = 7A$		20		S
Input Capacitance	$C_{ISS}$	$V_{GS} = 0V, V_{DS} = 10V,$ $f = 1MHz$	-	1150		pF
Output Capacitance	$C_{OSS}$		-	185		pF
Reverse Transfer Capacitance	$C_{RSS}$		-	145		pF
Turn-On Delay Time	$t_{d(on)}$	$V_{DD} = 10V, R_{GEN} = 3\Omega,$ $V_{GS} = 5V, R_L = 1.35\Omega$	-	6		nS
Turn-On Rise Time	$t_r$		-	13		nS
Turn-Off Delay Time	$t_{d(off)}$		-	52		nS
Turn-Off Fall Time	$t_f$		-	16		nS
Total Gate Charge	$Q_g$	$V_{DS} = 10V, I_D = 7A,$ $V_{GS} = 4.5V$		15		nC
Gate-Source Charge	$Q_{gs}$			0.8		nC
Gate-Drain Charge	$Q_{gd}$			3.2		nC
Diode Forward Voltage	$V_{SD}$	$V_{GS} = 0V, I_S = 1A$			1.2	V
Diode Forward Current	$I_S$				7	A

**Note 1:** Repetitive Rating: Pulse width lidth limited by maximum junction temperature.

**Note 2:** Surface Mounted on FR4 Board,  $t_s \leq 10$  sec

Typical Characteristics

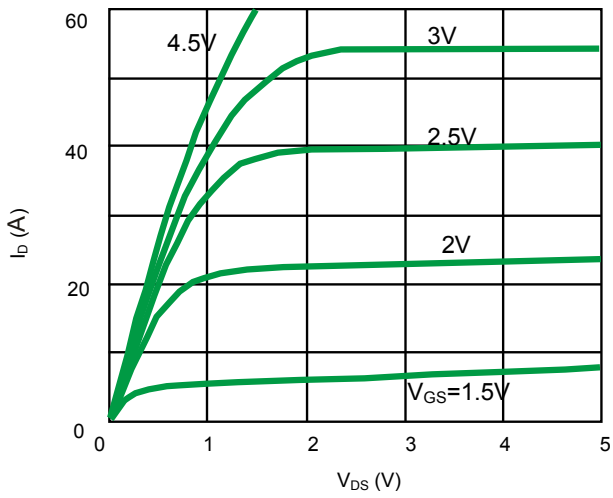

Fig 1. On-Region Characteristics

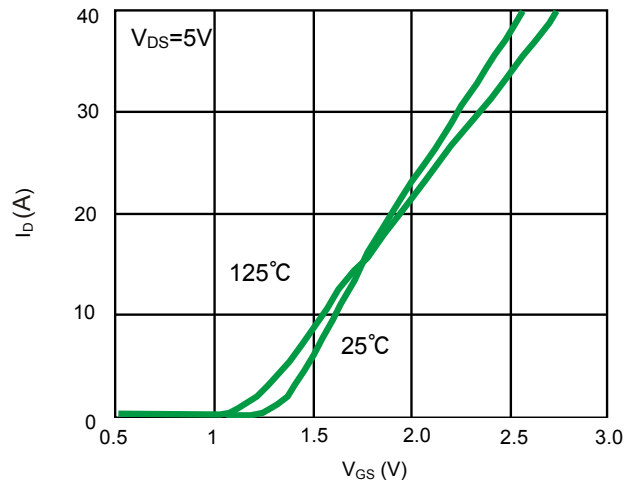

Fig 2. Transfer Characteristics

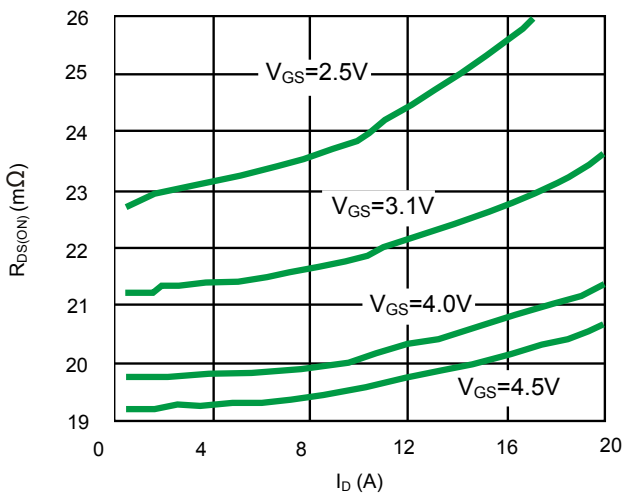

Fig 3. On-Resistance vs. Drain Current and gate Voltage

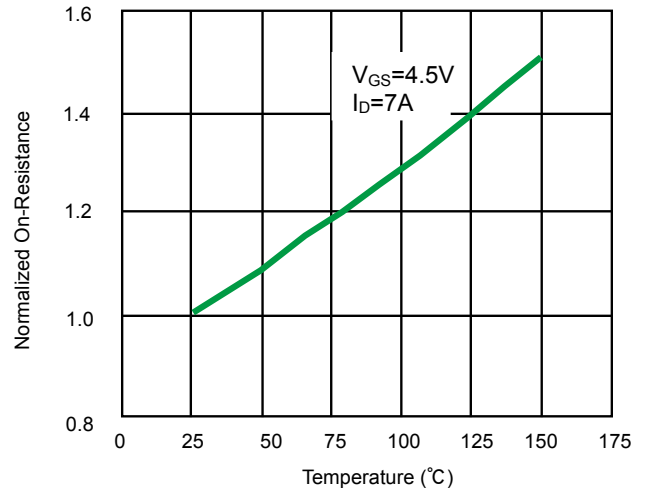

Fig 4. On-Resistance vs. Junction Temperature

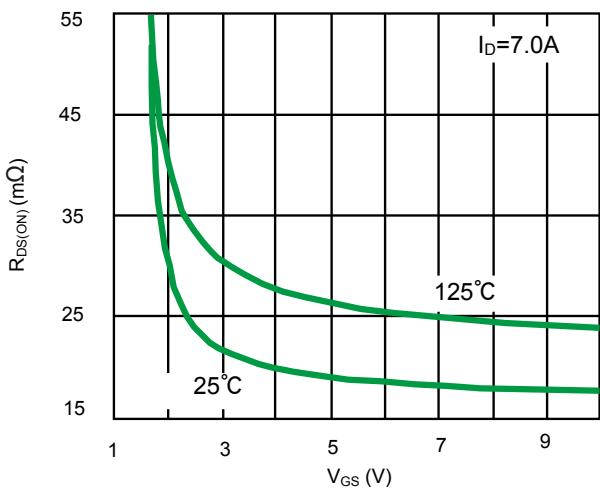

Fig 5. On-Resistance vs. Gate-Source Voltage

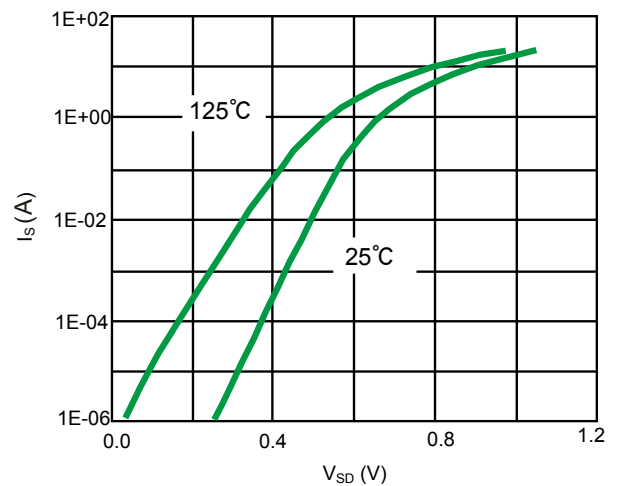

Fig 6. Body-Diode Characteristics

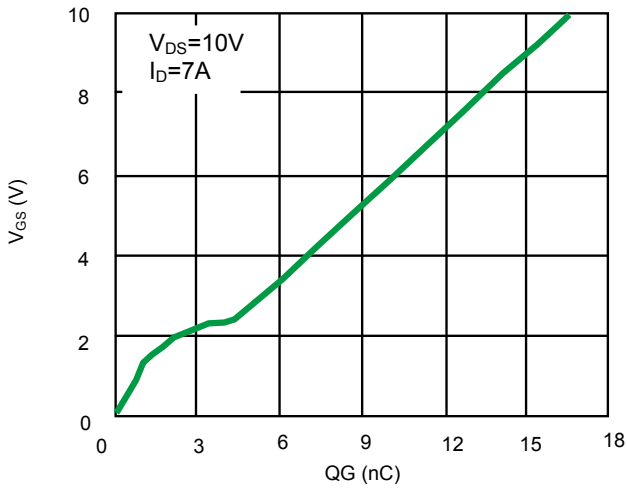

Fig 7. Gate Charge Characteristics

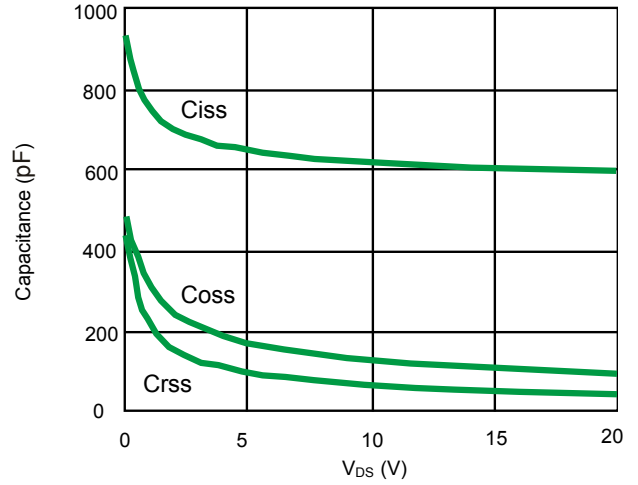

Fig 8. Capacitance Characteristics

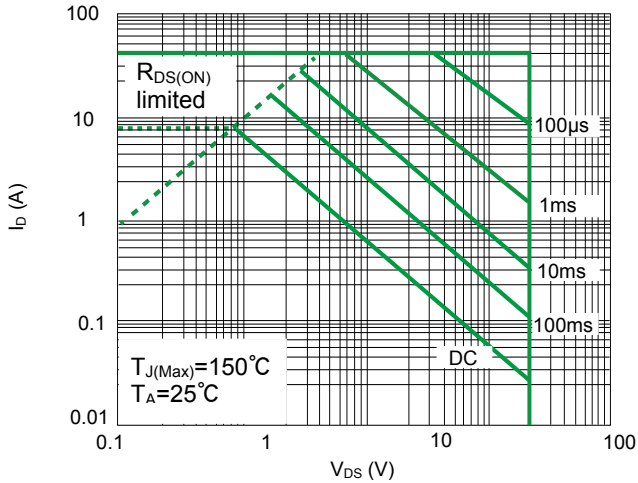

Fig 9. Maximum Forward Biased Safe Operating Area

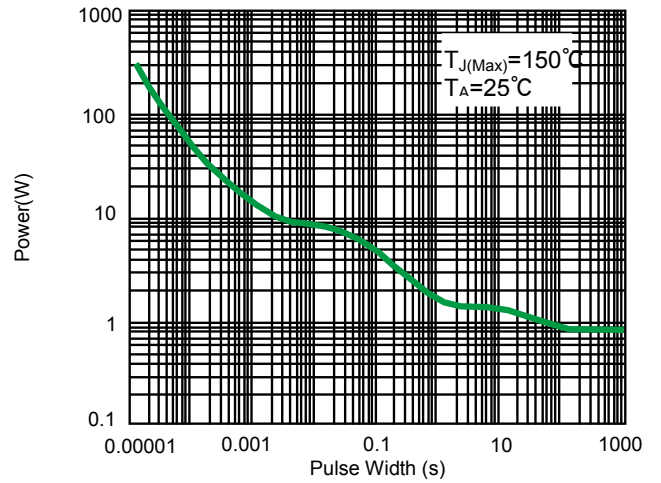

Fig 10. Single Pulse Power Rating Junction-to-Ambient

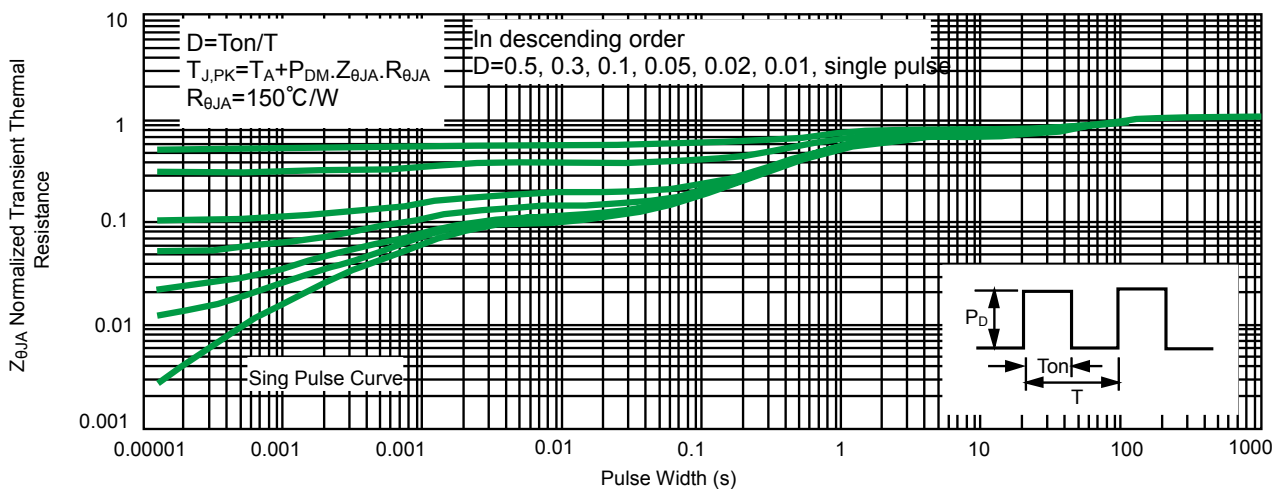
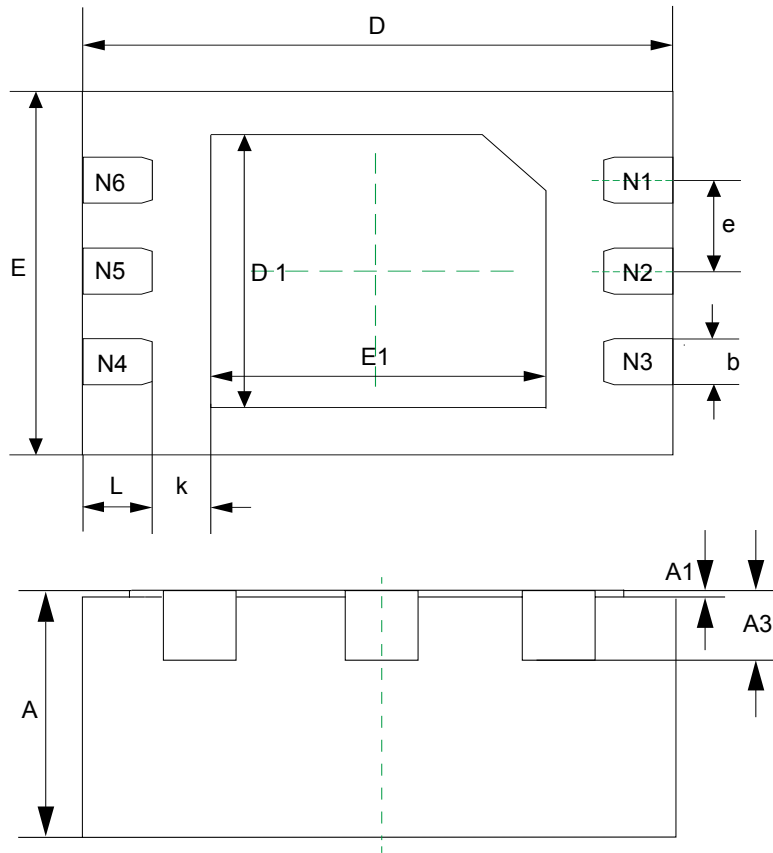
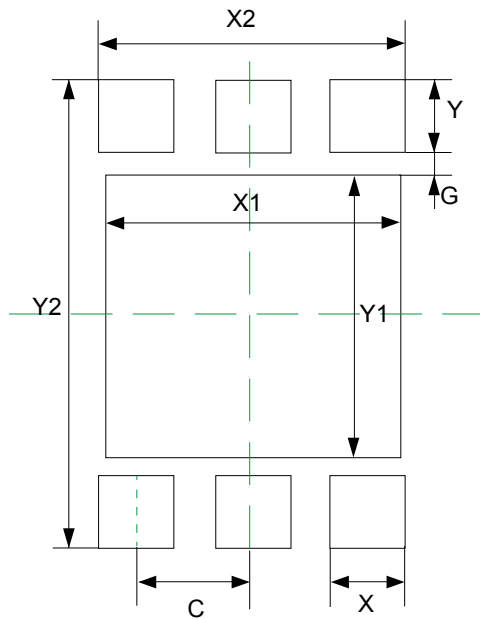

Fig 11. Normalized Maximum Transient Thermal Impedance



Dim	Millimeters		Inches	
	MIN	MAX	MIN	MAX
A	0.700	0.800	0.028	0.031
A1	0.000	0.050	0.000	0.002
A3	0.203REF		0.008REF	
D	2.950	3.050	0.116	0.120
E	1.950	2.050	0.077	0.081
D1	1.450	1.550	0.057	0.061
E1	1.650	1.750	0.065	0.069
k	0.200MIN		0.008MIN	
b	0.200	0.300	0.008	0.012
e	0.500TYP		0.020TYP	
L	0.300	0.400	0.012	0.016



Dim	Millimeters
C	0.650
G	0.150
X	0.400
X1	1.600
X2	1.700
Y	0.530
Y1	1.940
Y2	3.300

**Ordering information**

Device	Package	Shipping
PDNM6N20V7E	DFN2*3-6L (Pb-Free)	3000 / Tape & Reel

**IMPORTANT NOTICE**

 and **Prisemi**<sup>®</sup> are registered trademarks of **Prisemi Electronics Co., Ltd (Prisemi)** ,Prisemi reserves the right to make changes without further notice to any products herein. Prisemi makes no warranty, representation or guarantee regarding the suitability of its products for any particular purpose, nor does Prisemi assume any liability arising out of the application or use of any product or circuit, and specifically disclaims any and all liability, including without limitation special, consequential or incidental damages. “Typical” parameters which may be provided in Prisemi data sheets and/or specifications can and do vary in different applications and actual performance may vary over time. All operating parameters, including “Typicals” must be validated for each customer application by customer’s technical experts. Prisemi does not convey any license under its patent rights nor the rights of others. The products listed in this document are designed to be used with ordinary electronic equipment or devices, Should you intend to use these products with equipment or devices which require an extremely high level of reliability and the malfunction of with would directly endanger human life (such as medical instruments, aerospace machinery, nuclear-reactor controllers, fuel controllers and other safety devices), please be sure to consult with our sales representative in advance.

Website: <http://www.prisemi.com>

For additional information, please contact your local Sales Representative.

©Copyright 2009, Prisemi Electronics

 **Prisemi**<sup>®</sup> is a registered trademark of Prisemi Electronics.

All rights are reserved.