

Description

The PNMTOF650V10 is a high voltage power MOSFET and is designed to have better characteristics, such as fast switching time, low gate charge, low on-state resistance and have a high rugged avalanche characteristics. This power MOSFET is usually used at high speed switching applications in switching power supplies and adaptors.

Feature

- $R_{DS(ON)} \leq 1.0 \Omega @ V_{GS}=10V, I_D=5A$
- Fast switching capability
- Avalanche energy tested
- Improved dv/dt capability, high ruggedness

Applications

- Automotive applications
- Power switching application
- Hard switched and high frequency circuits
- Uninterruptible power supply

Mechanical data

- Case: TO-220F-3L
- Approx. Weight: 1.767g (0.062oz)
- Lead free finish, RoHS compliant
- Case Material: "Green" molding compound, UL flammability classification 94V-0, "Halogen-free".

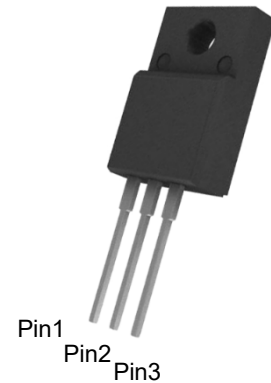

TO-220F-3L (Top View)

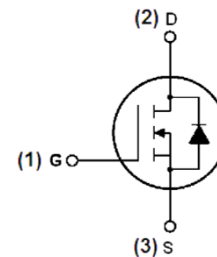

Schematic diagram

Absolute maximum rating@25°C

Rating	Symbol	Value	Units
Drain-Source Voltage	V_{DS}	650	V
Gate-Source Voltage	V_{GS}	± 30	V
Drain Current-Continuous	I_D	$T_C=25^\circ C$	10
		$T_C=100^\circ C$	6.3
Pulsed Drain Current	I_{DM}	40	A
Single Pulse Avalanche Energy	E_{AS}	500	mJ
Peak Diode Recovery dv/dt	dv/dt	2.1	V/ns
Maximum Power Dissipation	P_D	65	W
Junction and Storage Temperature Range	T_J, T_{STG}	-55~+150	°C
Junction-to-Ambient	$R_{\theta JA}$	63	°C/W
Junction-to-Case	$R_{\theta JC}$	4.0	°C/W

Electrical characteristics per line@25°C (unless otherwise specified)

Parameter	Symbol	Conditions	Min.	Typ.	Max.	Units
Off Characteristics						
Drain-Source Breakdown Voltage	BV_{DSS}	$V_{GS}=0V, I_D=250\mu A$	650	-	-	V
Zero Gate Voltage Drain Current	I_{DSS}	$V_{DS}=650V, V_{GS}=0V$	-	-	1.0	μA
Gate-Body Leakage Current	I_{GSS}	$V_{GS}=\pm 30V, V_{DS}=0V$	-	-	± 100	nA
On Characteristics						
Gate Threshold Voltage	$V_{GS(th)}$	$V_{DS}=V_{GS}, I_D=250\mu A$	2.0	-	4.0	V
Static Drain-Source On-Resistance	$R_{DS(on)}$	$V_{GS}=10V, I_D=5A$	-	0.77	1.0	Ω
Forward Transfer Conductance	g_{fs}	$V_{DS}=15V, I_D=2A$	-	4.8	-	S
Dynamic Parameters						
Input Capacitance	C_{iss}	$V_{DS}=15V, V_{GS}=0V, f=1MHz$	-	1601	-	pF
Output Capacitance	C_{oss}		-	137	-	
Reverse Transfer Capacitance	C_{rss}		-	11	-	
Gate Resistance	R_G	-	-	2.7	-	Ω
Switching Parameters						
Turn-on Delay Time	$t_{d(on)}$	$V_{DS}=325V, V_{GS}=10V, R_G=25\Omega, I_D=10A$	-	23	-	ns
Turn-on Rise Time	t_r		-	15	-	
Turn-Off Delay Time	$t_{d(off)}$		-	90	-	
Turn-Off Fall Time	t_f		-	30	-	
Total Gate Charge	Q_g	$V_{DS}=520V, I_D=10A, V_{GS}=10V$	-	35	-	nC
Gate-Source Charge	Q_{gs}		-	7.0	-	
Gate-Drain Charge	Q_{gd}		-	18	-	
Drain-Source Diode Characteristics						
Body Diode Reverse Recovery Time	t_{rr}	$I_F=10A, di/dt=100A/\mu s, V_{GS}=0V$	-	320	-	ns
Body Diode Reverse Recovery Charge	Q_{rr}		-	4.2	-	μC
Diode Forward Current	I_S	-	-	-	10	A
Diode Pulsed Current	I_{SM}	-	-	-	40	A
Diode Forward Voltage	V_{SD}	$V_{GS}=0V, I_S=10A$	-	-	1.4	V

Typical Characteristics

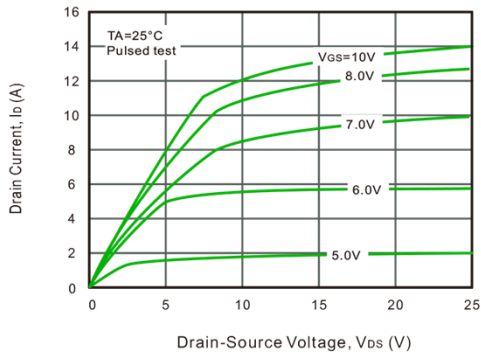

Fig.1 Output characteristics

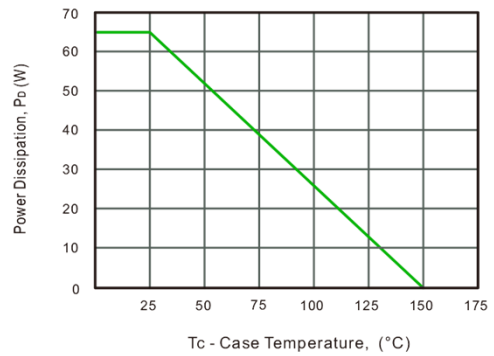

Fig.2 Power Dissipation

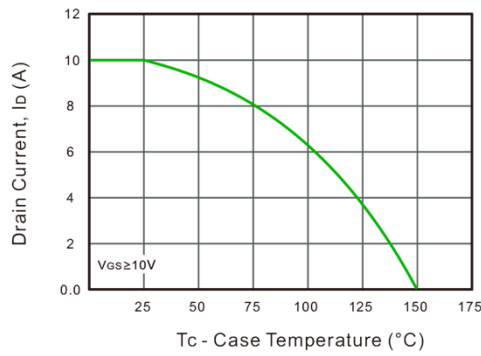

Fig.3 Drain Current Derating

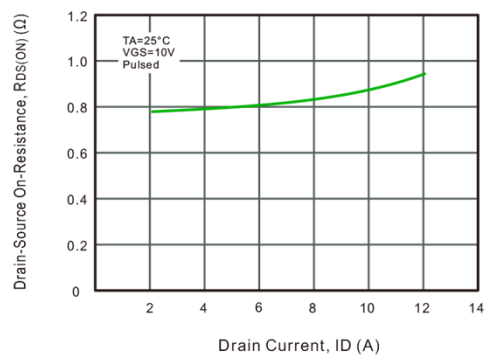

Fig.4 Drain-Source On-Resistance vs. Drain Current

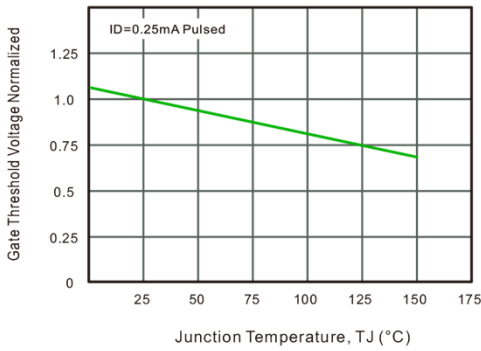

Fig.5 Gate Threshold Voltage vs. Junction Temperature

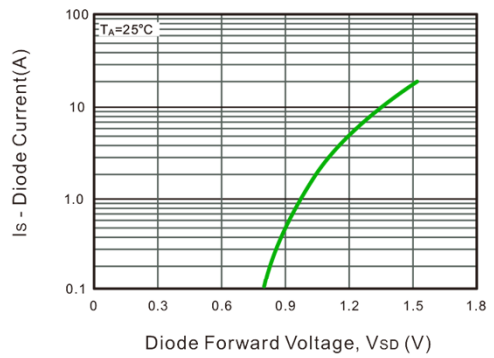

Fig.6 Body-diode Forward Characteristics

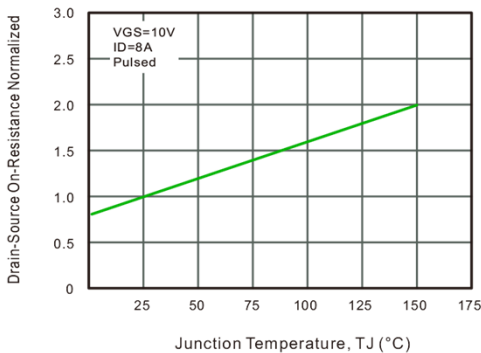

Fig.7 Drain-Source On-Resistance vs. Junction Temperature

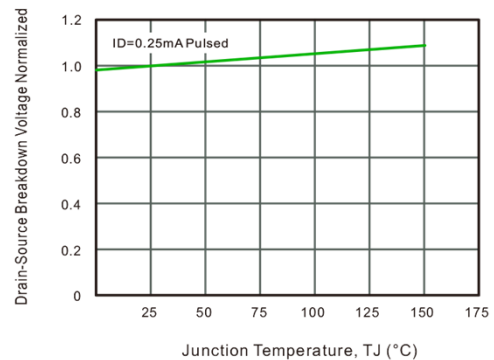
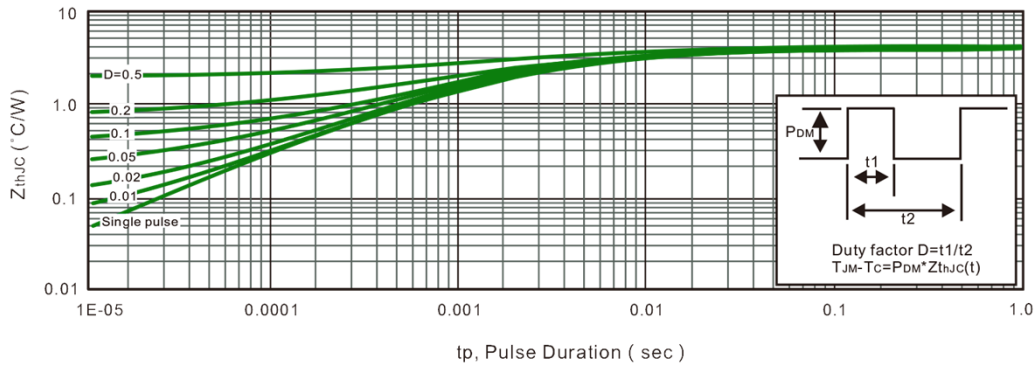
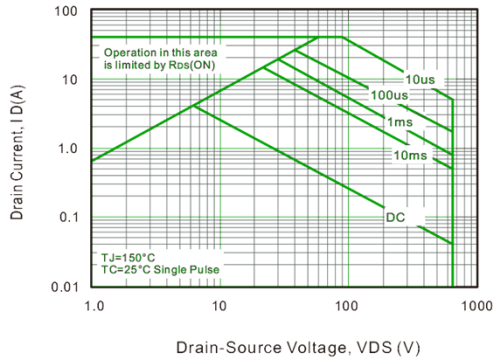
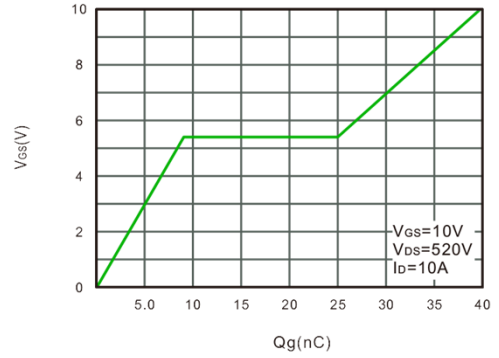
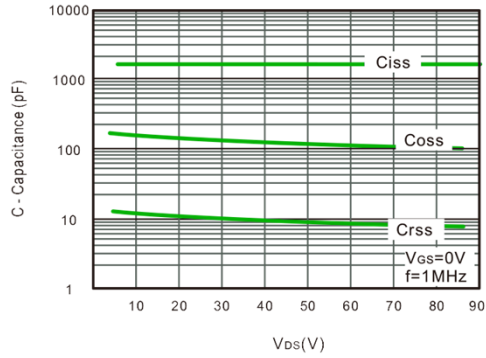
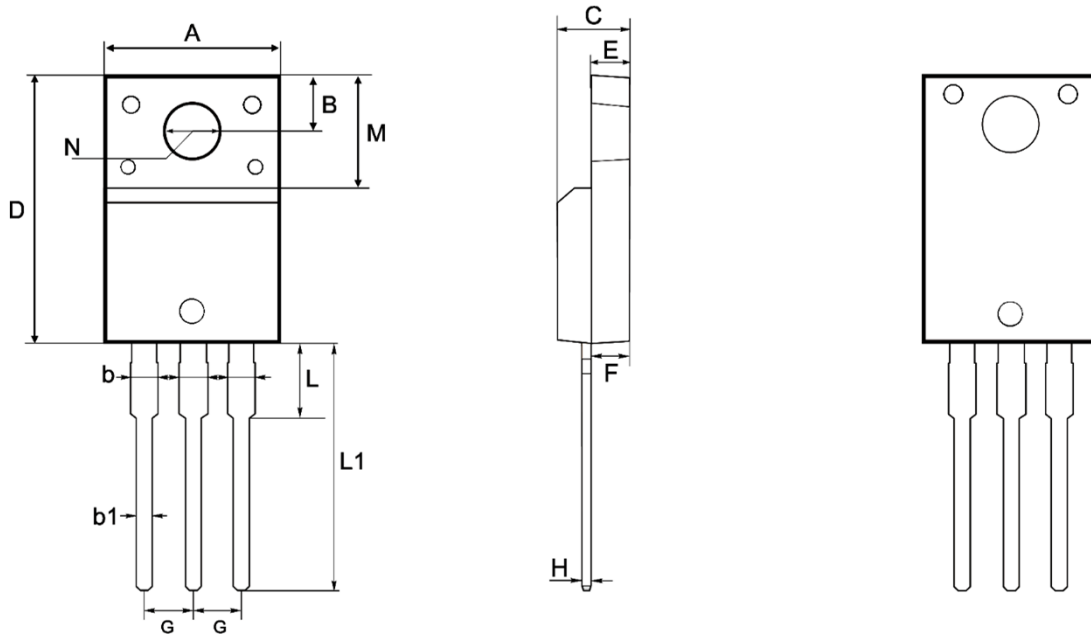

Fig.8 Breakdown Voltage vs. Junction Temperature



Product dimension (TO-220F-3L)



Dim	Millimeters		Inches	
	Min	Max	Min	Max
A	10.08	10.28	0.397	0.405
B	3.17	3.37	0.125	0.133
b	1.24	1.44	0.049	0.057
b1	0.70	0.90	0.028	0.035
C	4.50	4.90	0.177	0.193
D	15.67	16.07	0.617	0.633
E	2.34	2.74	0.092	0.108
F	2.34	2.74	0.092	0.108
G	2.44	2.64	0.096	0.104
H	0.40	0.60	0.016	0.024
L	2.98	3.38	0.117	0.133
L1	13.30	13.70	0.524	0.539
M	6.38	6.98	0.251	0.275
N	3.18 Typ.		0.125 Typ.	

IMPORTANT NOTICE

 and **Prisemi**[®] are registered trademarks of **Prisemi Electronics Co., Ltd** (Prisemi), Prisemi reserves the right to make changes without further notice to any products herein. Prisemi makes no warranty, representation or guarantee regarding the suitability of its products for any particular purpose, nor does Prisemi assume any liability arising out of the application or use of any product or circuit, and specifically disclaims any and all liability, including without limitation special, consequential or incidental damages. "Typical" parameters which may be provided in Prisemi data sheets and/or specifications can and do vary in different applications and actual performance may vary over time. All operating parameters, including "Typicals" must be validated for each customer application by customer's technical experts. Prisemi does not convey any license under its patent rights nor the rights of others. The products listed in this document are designed to be used with ordinary electronic equipment or devices, Should you intend to use these products with equipment or devices which require an extremely high level of reliability and the malfunction of with would directly endanger human life (such as medical instruments, aerospace machinery, nuclear-reactor controllers, fuel controllers and other safety devices), please be sure to consult with our sales representative in advance.

Website: <http://www.prisemi.com>

For additional information, please contact your local Sales Representative.

©Copyright 2009, Prisemi Electronics

 **Prisemi**[®] is a registered trademark of Prisemi Electronics.

All rights are reserved.