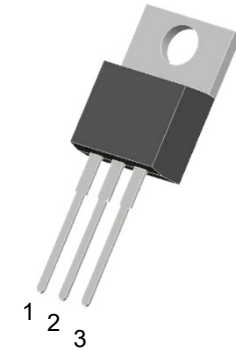

Description

The PNMTO600V5 is a high voltage MOSFET and is designed to have better characteristics, such as fast switching time, low gate charge, low on-state resistance and have a high rugged avalanche characteristics. This power MOSFET is usually used at high speed switching applications in power supplies, PWM motor controls, high efficient DC to DC converters and bridge circuits.

TO-220 (Top View)

MOSFET Product Summary

$V_{DS}(V)$	$R_{DS(on)}(\Omega)$	$I_D(A)$
600	2.04 @ $V_{GS} = 10V$	5

Feature

- Fast switching capability
- Avalanche energy tested
- Improved dv/dt capability, high ruggedness

Mechanical Characteristics

- Case: TO-220-3L
- Approx. Weight: 2.0g (0.07oz)
- Lead free finish, RoHS compliant
- Case Material: "Green" molding compound, UL flammability classification 94V-0, "Halogen-free".

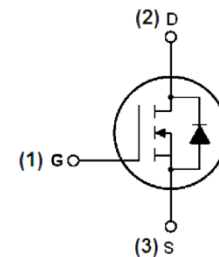
Schematic diagram

Absolute maximum rating@25°C

Rating	Symbol	Value	Units
Drain-Source Voltage	V_{DSS}	600	V
Gate-Source Voltage	V_{GSS}	±30	V
Drain Current-Continuous	I_D	Tc=25°C	5
		Tc=100°C	3.2
Pulsed Drain Current ²⁾	I_{DM}	20	A
Avalanche Energy Single Pulsed ³⁾	E_{AS}	310	mJ
Peak Diode Recovery dv/dt ⁴⁾	dv/dt	2.1	V/ns
Maximum Power Dissipation	P_D	113	W
Thermal Resistance , Junction-case	$R_{\theta JC}$	1.14	°C/W
Thermal Resistance Junction-to-Ambient	$R_{\theta JA}$	62.5	°C/W
Junction and Storage Temperature Range	T_J, T_{STG}	-55~+150	°C

Notes:

1. Absolute maximum ratings are those values beyond which the device could be permanently damaged. Absolute maximum ratings are stress ratings only and functional device operation is not implied.

2. Repetitive Rating: Pulse width limited by maximum junction temperature.

3. L = 100mH, $I_{AS} = 4.1A$, $V_{DD} = 50V$, $R_G = 25 \Omega$, Starting $T_J = 25^\circ C$

4. $I_{SD} \leq 10A$, $di/dt \leq 200A/\mu s$, $V_{DD} \leq BV_{DSS}$, Starting $T_J = 25^\circ C$

Electrical characteristics per line@25°C (unless otherwise specified)

Parameter	Symbol	Conditions	Min.	Typ.	Max.	Units
Off Characteristics						
Drain-Source Breakdown Voltage	BV_{DSS}	$V_{GS} = 0V, I_D = 250\mu A$	600	-	-	V
Zero Gate Voltage Drain Current	I_{DSS}	$V_{DS} = 600V, V_{GS} = 0V$	-	-	1.0	μA
Gate-Body Leakage Current	I_{GSS}	$V_{GS} = \pm 30V, V_{DS} = 0V$	-	-	± 100	nA
On Characteristics						
Gate Threshold Voltage	$V_{GS(th)}$	$V_{DS} = V_{GS}, I_D = 250\mu A$	2.0	3.2	4.0	V
Drain-Source On-State Resistance	$R_{DS(on)}$	$V_{GS} = 10V, I_D = 2.5A$	-	2.04	2.5	Ω
Dynamic Characteristics						
Input Capacitance	C_{iss}	$V_{DS} = 25V, V_{GS} = 0V,$ $F = 1.0MHz$	-	564	-	pF
Output Capacitance	C_{oss}		-	66	-	
Reverse Transfer Capacitance	C_{rss}		-	12	-	
Switching Characteristics						
Total Gate Charge ¹⁾	Q_g	$V_{DS} = 400V, V_{GS} = 10V$ $I_D = 5A, I_G = 1mA^{1)2)}$	-	13	-	nC
Gate-Source Charge	Q_{gs}		-	4.0	-	
Gate-Drain Charge	Q_{gd}		-	2.2	-	
Turn-on Delay Time ¹⁾	$t_{d(on)}$	$V_{DD} = 300V, V_{GS} = 10V,$ $I_D = 4A, R_G = 25\Omega^{1)2)}$	-	7.0	-	ns
Turn-on Rise Time	t_r		-	16	-	
Turn-Off Delay Time	$t_{d(off)}$		-	36	-	
Turn-Off Fall Time	t_f		-	22	-	
Drain-Source Diode Characteristics						
Diode Forward Current	I_{SD}		-	-	4.0	A
Pulsed Drain-Source Current	I_{SM}		-	-	16	A
Diode Forward Voltage ¹⁾	V_{SD}	$V_{GS} = 0V, I_S = 5A$	-	-	1.4	V
Reverse Recovery Time ¹⁾	t_{rr}	$V_{GS} = 0V, I_S = 5.0A,$ $di/dt = 100A/\mu s$	-	250	-	nS
Reverse Recovery Charge	Q_{rr}		-	4.5	-	μC

Notes:

1. Pulse Test: Pulse width $\leq 300\mu s$, Duty cycle $\leq 2\%$.
2. Essentially independent of operating temperature.

Typical Characteristics

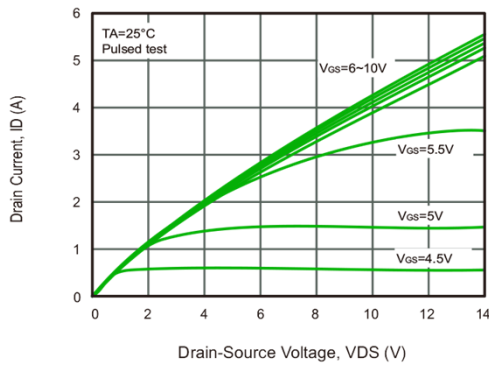

Fig.1 Drain Current vs. Gate-Source Voltage

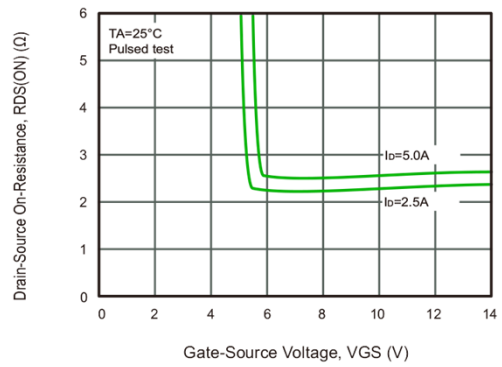

Fig.2 Drain-Source On-Resistance vs. Gate-Source Voltage

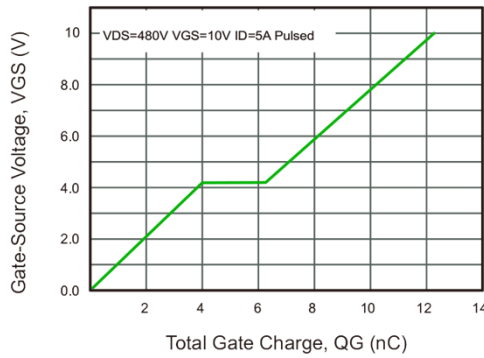

Fig.3 Gate Charge Characteristics

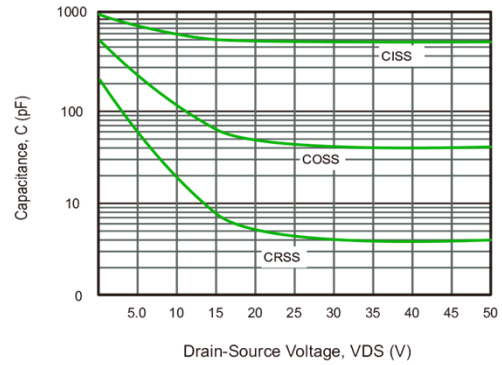

Fig.4 Capacitance Characteristics

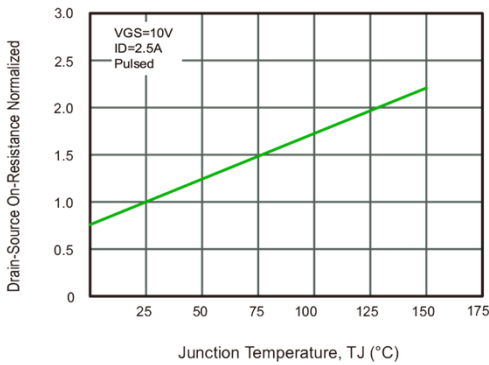

Fig.5 Drain-Source On-Resistance vs. Junction Temperature

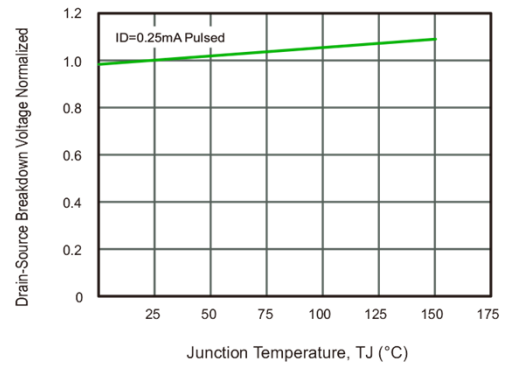

Fig.6 Breakdown Voltage vs. Junction Temperature

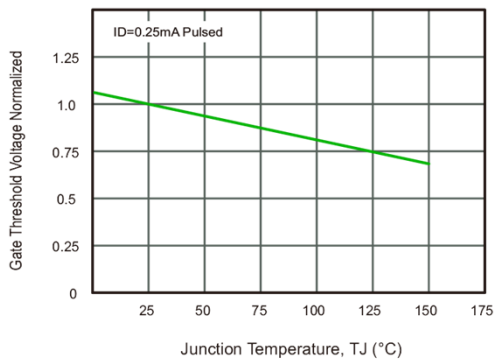

Fig.7 Gate Threshold Voltage vs. Junction Temperature

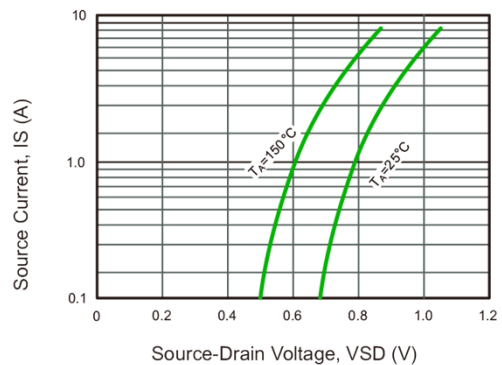

Fig.8 Source Current vs. Source-Drain Voltage

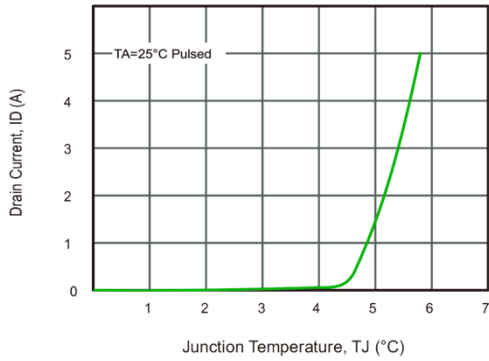

Fig.9 Drain Current vs. Gate-Source Voltage

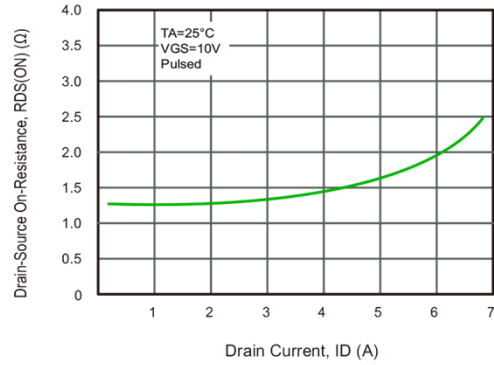

Fig.10 Drain-Source On-Resistance vs. Drain Current

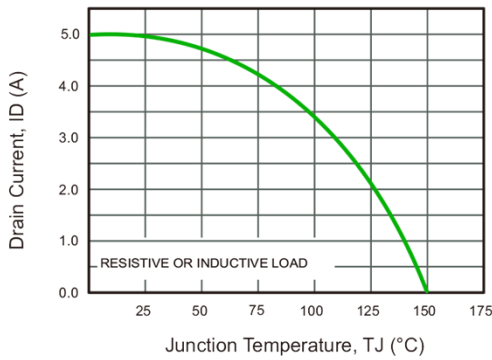

Fig.11 Drain Current vs. Junction Temperature

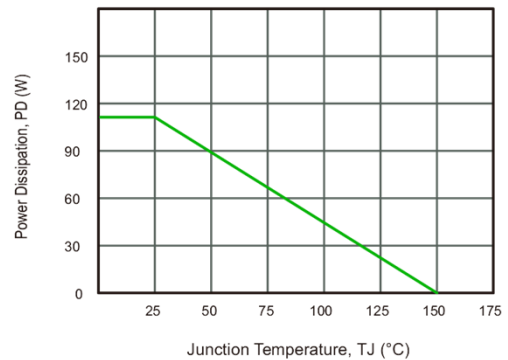

Fig.12 Power Dissipation vs. Junction Temperature

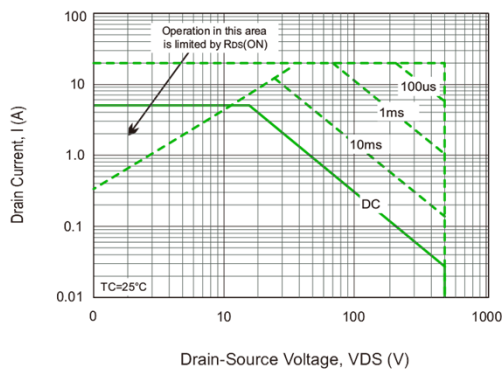
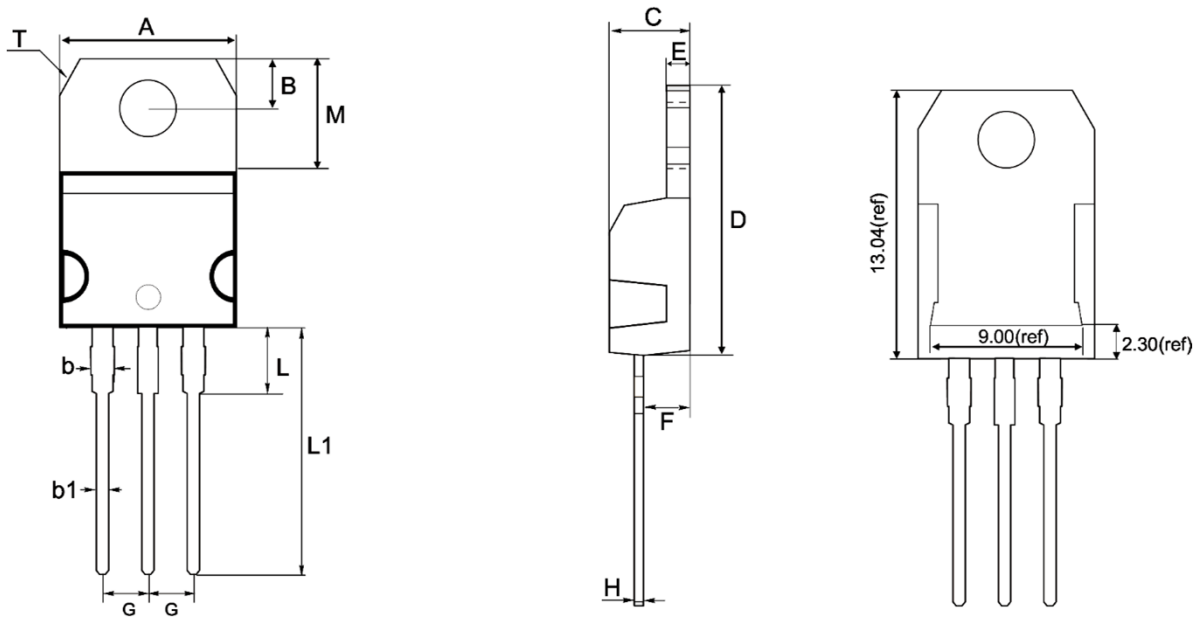



Fig.13 Safe Operating Area

Product dimension (TO-220-3L)



Dim	Millimeters		Inches	
	Min	Max	Min	Max
A	10.08	10.28	0.397	0.405
B	2.64	2.84	0.104	0.112
b	1.18	1.48	0.046	0.058
b1	0.70	0.90	0.028	0.035
C	4.25	4.65	0.167	0.183
D	15.14	15.54	0.596	0.612
E	1.17	1.37	0.046	0.054
F	2.39	2.79	0.094	0.110
G	2.44	2.64	0.096	0.104
H	0.40	0.60	0.016	0.024
L	3.48	3.88	0.137	0.153
L1	12.73	13.13	0.501	0.517
M	5.99	6.39	0.236	0.252
N	3.82 Typ.		0.150 Typ.	
T	1.19 Typ.		0.047 Typ.	

IMPORTANT NOTICE

 and **Prisemi**[®] are registered trademarks of **Prisemi Electronics Co., Ltd** (Prisemi), Prisemi reserves the right to make changes without further notice to any products herein. Prisemi makes no warranty, representation or guarantee regarding the suitability of its products for any particular purpose, nor does Prisemi assume any liability arising out of the application or use of any product or circuit, and specifically disclaims any and all liability, including without limitation special, consequential or incidental damages. "Typical" parameters which may be provided in Prisemi data sheets and/or specifications can and do vary in different applications and actual performance may vary over time. All operating parameters, including "Typicals" must be validated for each customer application by customer's technical experts. Prisemi does not convey any license under its patent rights nor the rights of others. The products listed in this document are designed to be used with ordinary electronic equipment or devices, Should you intend to use these products with equipment or devices which require an extremely high level of reliability and the malfunction of with would directly endanger human life (such as medical instruments, aerospace machinery, nuclear-reactor controllers, fuel controllers and other safety devices), please be sure to consult with our sales representative in advance.

Website: <http://www.prisemi.com>

For additional information, please contact your local Sales Representative.

©Copyright 2009, Prisemi Electronics

 **Prisemi**[®] is a registered trademark of Prisemi Electronics.

All rights are reserved.